



**COMMONWEALTH OF PENNSYLVANIA
DEPARTMENT OF ENVIRONMENTAL PROTECTION
AIR QUALITY PROGRAM**

STATE ONLY SYNTHETIC MINOR OPERATING PERMIT

Issue Date: January 17, 2023

Effective Date: January 17, 2023

Expiration Date: January 16, 2028

In accordance with the provisions of the Air Pollution Control Act, the Act of January 8, 1960, P.L. 2119, as amended, and 25 Pa. Code Chapter 127, the Owner, [and Operator if noted] (hereinafter referred to as permittee) identified below is authorized by the Department of Environmental Protection (Department) to operate the air emission source(s) more fully described in this permit. This Facility is subject to all terms and conditions specified in this permit. Nothing in this permit relieves the permittee from its obligations to comply with all applicable Federal, State and Local laws and regulations.

The regulatory or statutory authority for each permit condition is set forth in brackets. All terms and conditions in this permit are federally enforceable unless otherwise designated.

State Only Permit No: 49-00009

Synthetic Minor

Federal Tax Id - Plant Code: 64-0198020-3

Owner Information

Name: MASONITE CORP

Mailing Address: 980 POINT TOWNSHIP DR
NORTHUMBERLAND, PA 17857-8886

Plant Information

Plant: MASONITE CORP/NORTHUMBERLAND DOOR PLT

Location: 49 Northumberland County 49922 Point Township

SIC Code: 2431 Manufacturing - Millwork

Responsible Official

Name: DUSTIN HARRIS

Title: PLANT MGR

Phone: (570) 560 - 2855

Email: dharris@masonite.com

Permit Contact Person

Name: SCOTT TOEVS

Title: EHS MANAGER

Phone: (570) 473 - 1321

Email: stoevs@masonite.com

[Signature] _____

MUHAMMAD Q. ZAMAN, ENVIRONMENTAL PROGRAM MANAGER, NORTHCENTRAL REGION



SECTION A. Table of Contents

Section A. Facility/Source Identification

Table of Contents
Site Inventory List

Section B. General State Only Requirements

- #001 Definitions.
- #002 Operating Permit Duration.
- #003 Permit Renewal.
- #004 Operating Permit Fees under Subchapter I.
- #005 Transfer of Operating Permits.
- #006 Inspection and Entry.
- #007 Compliance Requirements.
- #008 Need to Halt or Reduce Activity Not a Defense.
- #009 Duty to Provide Information.
- #010 Revising an Operating Permit for Cause.
- #011 Operating Permit Modifications
- #012 Severability Clause.
- #013 De Minimis Emission Increases.
- #014 Operational Flexibility.
- #015 Reactivation
- #016 Health Risk-based Emission Standards and Operating Practice Requirements.
- #017 Circumvention.
- #018 Reporting Requirements.
- #019 Sampling, Testing and Monitoring Procedures.
- #020 Recordkeeping.
- #021 Property Rights.
- #022 Alternative Operating Scenarios.
- #023 Reporting
- #024 Report Format

Section C. Site Level State Only Requirements

- C-I: Restrictions
- C-II: Testing Requirements
- C-III: Monitoring Requirements
- C-IV: Recordkeeping Requirements
- C-V: Reporting Requirements
- C-VI: Work Practice Standards
- C-VII: Additional Requirements
- C-VIII: Compliance Certification
- C-IX: Compliance Schedule

Section D. Source Level State Only Requirements

- D-I: Restrictions
- D-II: Testing Requirements
- D-III: Monitoring Requirements
- D-IV: Recordkeeping Requirements
- D-V: Reporting Requirements
- D-VI: Work Practice Standards
- D-VII: Additional Requirements

Note: These same sub-sections are repeated for each source!

Section E. Source Group Restrictions

- E-I: Restrictions



SECTION A. Table of Contents

- E-II: Testing Requirements
- E-III: Monitoring Requirements
- E-IV: Recordkeeping Requirements
- E-V: Reporting Requirements
- E-VI: Work Practice Standards
- E-VII: Additional Requirements

Section F. Alternative Operating Scenario(s)

- F-I: Restrictions
- F-II: Testing Requirements
- F-III: Monitoring Requirements
- F-IV: Recordkeeping Requirements
- F-V: Reporting Requirements
- F-VI: Work Practice Standards
- F-VII: Additional Requirements

Section G. Emission Restriction Summary

Section H. Miscellaneous

**SECTION A. Site Inventory List**

Source ID	Source Name	Capacity/Throughput	Fuel/Material
031	WEIL-MCLAIN BOILER		
032	KEWANEE BOILER		
033	SPACE HEATERS		
P101	SPRAY BOOTH 1		
P102	SPRAY BOOTH 2		
P103	SPRAY BOOTH 3		
P105	SPRAY BOOTH 4		
P106	PREFINISH LINE		
P106A	PREFINISH LINE ADDITION #1		
P107	GLUING OPERATIONS		
P108	MILLING AND SANDING OPERATIONS		
P109	CLEANUP OPERATIONS		
P111	EMERGENCY GENERATOR		
P112	SPRAY BOOTH 5		
P113	PARTS CLEANER		
P114	SPRAY BOOTH #6		
P115	AIR MAKE UP UNIT		
P117	AUTO PAINT LINE		
P118	MINI SPRAY BOOTH		
C108A	FABRIC COLLECTOR #1		
C108B	FABRIC COLLECTOR #2		
C108C	FABRIC COLLECTOR #3		
C108D	FABRIC COLLECTOR #4		
C108E	FABRIC COLLECTOR #5		
C108F	FABRIC COLLECTOR #6		
C114	PAINT ARRESTORS		
C117	PAINT ARRESTOR FILTERS		
C118	MINI SPRAY BOOTH FILTERS		
FM01	NATURAL GAS LINE		
S001	SPRAY BOOTH 1 STACK		
S002	SPRAY BOOTH 2 STACK		
S003	SPRAY BOOTH 3 STACK		
S005	SPRAY BOOTH 4 STACK		
S006	PREFINISH LINE STACKS		
S031	WEIL-MCLAIN BOILER EXHAUST		
S032	KEWANEE BOILER EXHAUST		
S033	SPACE HEATER STACKS		
S106A	PREFINISH LINE ADDITION #1 STACK		
S108A	COLLECTOR STACK #1		
S108B	COLLECTOR STACK #2		

**SECTION A. Site Inventory List**

Source ID	Source Name	Capacity/Throughput	Fuel/Material
S108C	COLLECTOR STACK #3		
S108D	COLLECTOR STACK #4		
S108E	COLLECTOR STACK #5		
S108F	COLLECTOR STACK #6		
S111	EMERGENCY GENERATOR STACK		
S112	SPRAY BOOTH 5 STACK		
S113	PARTS CLEANER FUGITIVES		
S114	SPRAY BOOTH #6 STACK		
S115	AIR MAKEUP UNIT VENT		
S117	AUTO PAINT LINE STACK		
S118	SPRAY BOOTH STACK		
Z107	GLUING OPERATION FUGITIVES		
Z109	CLEANUP FUGITIVES		

PERMIT MAPS



PERMIT MAPS

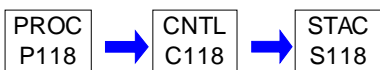
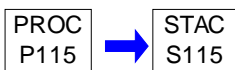
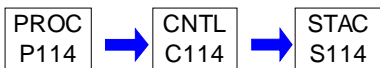
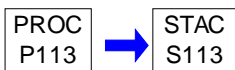
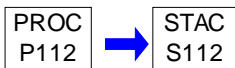
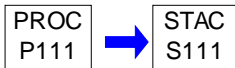
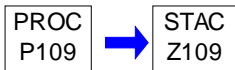
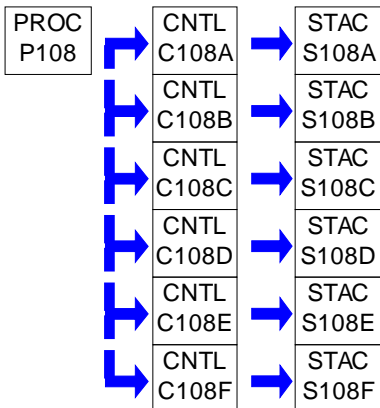
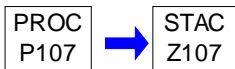
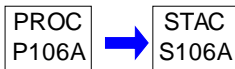
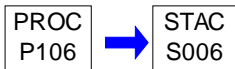

**SECTION B. General State Only Requirements****#001 [25 Pa. Code § 121.1]****Definitions.**

Words and terms that are not otherwise defined in this permit shall have the meanings set forth in Section 3 of the Air Pollution Control Act (35 P.S. § 4003) and in 25 Pa. Code § 121.1.

#002 [25 Pa. Code § 127.446]**Operating Permit Duration.**

- (a) This operating permit is issued for a fixed term of five (5) years and shall expire on the date specified on Page 1 of this permit.
- (b) The terms and conditions of the expired permit shall automatically continue pending issuance of a new operating permit, provided the permittee has submitted a timely and complete application and paid applicable fees required under 25 Pa. Code Chapter 127, Subchapter I and the Department is unable, through no fault of the permittee, to issue or deny a new permit before the expiration of the previous permit.

#003 [25 Pa. Code §§ 127.412, 127.413, 127.414, 127.446 & 127.703(b)]**Permit Renewal.**

- (a) The permittee shall submit a timely and complete application for renewal of the operating permit to the appropriate Regional Air Program Manager. The application for renewal of the operating permit shall be submitted at least six (6) months and not more than 18 months before the expiration date of this permit.
- (b) The application for permit renewal shall include the current permit number, a description of any permit revisions that occurred during the permit term, and any applicable requirements that were promulgated and not incorporated into the permit during the permit term. An application is complete if it contains sufficient information to begin processing the application, has the applicable sections completed and has been signed by a responsible official.
- (c) The permittee shall submit with the renewal application a fee for the processing of the application as specified in 25 Pa. Code § 127.703(b). The fees shall be made payable to "The Commonwealth of Pennsylvania Clean Air Fund" and submitted with the fee form to the respective regional office.
- (d) The renewal application shall also include submission of proof that the local municipality and county, in which the facility is located, have been notified in accordance with 25 Pa. Code § 127.413.
- (e) The application for renewal of the operating permit shall also include submission of supplemental compliance review forms in accordance with the requirements of 25 Pa. Code § 127.412(b) and § 127.412(j).
- (f) The permittee, upon becoming aware that any relevant facts were omitted or incorrect information was submitted in the permit application, shall promptly submit such supplementary facts or corrected information as necessary to address any requirements that become applicable to the source after the permittee submits a complete application, but prior to the date the Department takes action on the permit application.

#004 [25 Pa. Code § 127.703]**Operating Permit Fees under Subchapter I.**

- (a) The permittee shall pay the annual operating permit maintenance fee according to the following fee schedule in either paragraph (1) or (2) in accordance with 25 Pa. Code § 127.703(d) on or before December 31 of each year for the next calendar year.
- (1) For a synthetic minor facility, a fee equal to:
- (i) Four thousand dollars (\$4,000) for calendar years 2021—2025.
 - (ii) Five thousand dollars (\$5,000) for calendar years 2026—2030.
 - (iii) Six thousand three hundred dollars (\$6,300) for the calendar years beginning with 2031.

**SECTION B. General State Only Requirements**

(2) For a facility that is not a synthetic minor, a fee equal to:

- (i) Two thousand dollars (\$2,000) for calendar years 2021—2025.
- (ii) Two thousand five hundred dollars (\$2,500) for calendar years 2026—2030.
- (iii) Three thousand one hundred dollars (\$3,100) for the calendar years beginning with 2031.

(b) The applicable fees shall be made payable to "The Commonwealth of Pennsylvania Clean Air Fund" with the permit number clearly indicated and submitted to the respective regional office.

#005 [25 Pa. Code §§ 127.450 (a)(4) and 127.464]**Transfer of Operating Permits.**

(a) This operating permit may not be transferred to another person, except in cases of transfer-of-ownership that are documented and approved by the Department.

(b) In accordance with 25 Pa. Code § 127.450(a)(4), a change in ownership of the source shall be treated as an administrative amendment if the Department determines that no other change in the permit is required and a written agreement has been submitted to the Department identifying the specific date of the transfer of permit responsibility, coverage and liability between the current and the new permittee and a compliance review form has been submitted to, and the permit transfer has been approved by, the Department.

(c) This operating permit is valid only for those specific sources and the specific source locations described in this permit.

#006 [25 Pa. Code § 127.441 and 35 P.S. § 4008]**Inspection and Entry.**

(a) Upon presentation of credentials and other documents as may be required by law, the permittee shall allow the Department or authorized representatives of the Department to perform the following:

(1) Enter at reasonable times upon the permittee's premises where a source is located or emissions related activity is conducted, or where records are kept under the conditions of this permit;

(2) Have access to and copy, at reasonable times, any records that are kept under the conditions of this permit;

(3) Inspect at reasonable times, any facilities, equipment including monitoring and air pollution control equipment, practices, or operations regulated or required under this permit;

(4) Sample or monitor, at reasonable times, any substances or parameters, for the purpose of assuring compliance with the permit or applicable requirements as authorized by the Clean Air Act, the Air Pollution Control Act, or the regulations promulgated under the Acts.

(b) Pursuant to 35 P.S. § 4008, no person shall hinder, obstruct, prevent or interfere with the Department or its personnel in the performance of any duty authorized under the Air Pollution Control Act or regulations adopted thereunder including denying the Department access to a source at this facility. Refusal of entry or access may constitute grounds for permit revocation and assessment of criminal and/or civil penalties.

(c) Nothing in this permit condition shall limit the ability of the EPA to inspect or enter the premises of the permittee in accordance with Section 114 or other applicable provisions of the Clean Air Act.

#007 [25 Pa. Code §§ 127.441 & 127.444]**Compliance Requirements.**

(a) The permittee shall comply with the conditions of this operating permit. Noncompliance with this permit constitutes a violation of the Clean Air Act and the Air Pollution Control Act and is grounds for one or more of the following:

**SECTION B. General State Only Requirements**

- (1) Enforcement action
- (2) Permit termination, revocation and reissuance or modification
- (3) Denial of a permit renewal application

(b) A person may not cause or permit the operation of a source which is subject to 25 Pa. Code Article III unless the source(s) and air cleaning devices identified in the application for the plan approval and operating permit and the plan approval issued for the source is operated and maintained in accordance with specifications in the applications and the conditions in the plan approval and operating permit issued by the Department. A person may not cause or permit the operation of an air contamination source subject to 25 Pa. Code Chapter 127 in a manner inconsistent with good operating practices.

(c) For purposes of Sub-condition (b) of this permit condition, the specifications in applications for plan approvals and operating permits are the physical configurations and engineering design details which the Department determines are essential for the permittee's compliance with the applicable requirements in this State-Only permit. Nothing in this sub-condition shall be construed to create an independent affirmative duty upon the permittee to obtain a predetermination from the Department for physical configuration or engineering design detail changes made by the permittee.

#008 [25 Pa. Code § 127.441]**Need to Halt or Reduce Activity Not a Defense.**

It shall not be a defense for the permittee in an enforcement action that it was necessary to halt or reduce the permitted activity in order to maintain compliance with the conditions of this permit.

#009 [25 Pa. Code §§ 127.442(a) & 127.461]**Duty to Provide Information.**

(a) The permittee shall submit reports to the Department containing information the Department may prescribe relative to the operation and maintenance of each source at the facility.

(b) The permittee shall furnish to the Department, in writing, information that the Department may request to determine whether cause exists for modifying, revoking and reissuing, or terminating this permit, or to determine compliance with the permit. Upon request, the permittee shall also furnish to the Department copies of records that the permittee is required to maintain in accordance with this permit.

#010 [25 Pa. Code § 127.461]**Revising an Operating Permit for Cause.**

This operating permit may be terminated, modified, suspended or revoked and reissued if one or more of the following applies:

- (1) The permittee constructs or operates the source subject to the operating permit so that it is in violation of the Air Pollution Control Act, the Clean Air Act, the regulations thereunder, a plan approval, a permit or in a manner that causes air pollution.
- (2) The permittee fails to properly or adequately maintain or repair an air pollution control device or equipment attached to or otherwise made a part of the source.
- (3) The permittee has failed to submit a report required by the operating permit or an applicable regulation.
- (4) The EPA determines that the permit is not in compliance with the Clean Air Act or the regulations thereunder.

#011 [25 Pa. Code §§ 127.450, 127.462, 127.465 & 127.703]**Operating Permit Modifications**

(a) The permittee is authorized to make administrative amendments, minor operating permit modifications and significant operating permit modifications, under this permit, as outlined below:

**SECTION B. General State Only Requirements**

(b) Administrative Amendments. The permittee shall submit the application for administrative operating permit amendments (as defined in 25 Pa. Code § 127.450(a)), according to procedures specified in § 127.450 unless precluded by the Clean Air Act or its regulations.

(c) Minor Operating Permit Modifications. The permittee shall submit the application for minor operating permit modifications (as defined 25 Pa. Code § 121.1) in accordance with 25 Pa. Code § 127.462.

(d) Significant Operating Permit Modifications. The permittee shall submit the application for significant operating permit modifications in accordance with 25 Pa. Code § 127.465.

(e) The applicable fees shall be made payable to "The Commonwealth of Pennsylvania Clean Air Fund" with the permit number clearly indicated and submitted to the respective regional office.

#012 [25 Pa. Code § 127.441]**Severability Clause.**

The provisions of this permit are severable, and if any provision of this permit is determined by a court of competent jurisdiction to be invalid or unenforceable, such a determination will not affect the remaining provisions of this permit.

#013 [25 Pa. Code § 127.449]**De Minimis Emission Increases.**

(a) This permit authorizes de minimis emission increases in accordance with 25 Pa. Code § 127.449 so long as the permittee provides the Department with seven (7) days prior written notice before commencing any de minimis emissions increase. The written notice shall:

(1) Identify and describe the pollutants that will be emitted as a result of the de minimis emissions increase.

(2) Provide emission rates expressed in tons per year and in terms necessary to establish compliance consistent with any applicable requirement.

(b) The Department may disapprove or condition de minimis emission increases at any time.

(c) Except as provided below in (d), the permittee is authorized to make de minimis emission increases (expressed in tons per year) up to the following amounts without the need for a plan approval or prior issuance of a permit modification:

(1) Four tons of carbon monoxide from a single source during the term of the permit and 20 tons of carbon monoxide at the facility during the term of the permit.

(2) One ton of NO_x from a single source during the term of the permit and 5 tons of NO_x at the facility during the term of the permit.

(3) One and six-tenths tons of the oxides of sulfur from a single source during the term of the permit and 8.0 tons of oxides of sulfur at the facility during the term of the permit.

(4) Six-tenths of a ton of PM₁₀ from a single source during the term of the permit and 3.0 tons of PM₁₀ at the facility during the term of the permit. This shall include emissions of a pollutant regulated under Section 112 of the Clean Air Act unless precluded by the Clean Air Act, the regulations thereunder or 25 Pa. Code Article III.

(5) One ton of VOCs from a single source during the term of the permit and 5.0 tons of VOCs at the facility during the term of the permit. This shall include emissions of a pollutant regulated under Section 112 of the Clean Air Act unless precluded by the Clean Air Act, the regulations thereunder or 25 Pa. Code Article III.

(6) Other sources and classes of sources determined to be of minor significance by the Department.

(d) In accordance with § 127.14, the permittee is authorized to install the following minor sources without the need for a plan approval or permit modification:

**SECTION B. General State Only Requirements**

- (1) Air conditioning or ventilation systems not designed to remove pollutants generated or released from other sources.
 - (2) Combustion units rated at 2,500,000 or less Btu per hour of heat input.
 - (3) Combustion units with a rated capacity of less than 10,000,000 Btu per hour heat input fueled by natural gas supplied by a public utility or by commercial fuel oils which are No. 2 or lighter, viscosity less than or equal to 5.82 c St, and which meet the sulfur content requirements of 25 Pa. Code §123.22 (relating to combustion units). For purposes of this permit, commercial fuel oil shall be virgin oil which has no reprocessed, recycled or waste material added.
 - (4) Space heaters which heat by direct heat transfer.
 - (5) Laboratory equipment used exclusively for chemical or physical analysis.
 - (6) Other sources and classes of sources determined to be of minor significance by the Department.
- (e) This permit does not authorize de minimis emission increases if the emissions increase would cause one or more of the following:
- (1) Increase the emissions of a pollutant regulated under Section 112 of the Clean Air Act except as authorized in Subparagraphs (c)(4) and (5) of this permit condition.
 - (2) Subject the facility to the prevention of significant deterioration requirements in 25 Pa. Code Chapter 127, Subchapter D and/or the new source review requirements in Subchapter E.
 - (3) Violate any applicable requirement of this permit, the Air Pollution Control Act, the Clean Air Act, or the regulations promulgated under either of the acts.
- (f) Emissions authorized under this permit condition shall be included in the monitoring, recordkeeping and reporting requirements of this permit.
- (g) Except for de minimis emission increases, installation of minor sources made pursuant to this permit condition and Plan Approval Exemptions under 25 Pa. Code § 127.14 (relating to exemptions), the permittee is prohibited from making changes or engaging in activities that are not specifically authorized under this permit without first applying for a plan approval. In accordance with § 127.14(b), a plan approval is not required for the construction, modification, reactivation, or installation of the sources creating the de minimis emissions increase.
- (h) The permittee may not meet de minimis emission threshold levels by offsetting emission increases or decreases at the same source.

#014 [25 Pa. Code § 127.3]**Operational Flexibility.**

The permittee is authorized to make changes within the facility in accordance with the regulatory provisions outlined in 25 Pa. Code § 127.3 (relating to operational flexibility) to implement the operational flexibility requirements provisions authorized under Section 6.1(i) of the Air Pollution Control Act and the operational flexibility terms and conditions of this permit. The provisions in 25 Pa. Code Chapter 127 which implement the operational flexibility requirements include the following:

- (1) Section 127.14 (relating to exemptions)
- (2) Section 127.447 (relating to alternative operating scenarios)
- (3) Section 127.448 (relating to emissions trading at facilities with Federally enforceable emissions caps)
- (4) Section 127.449 (relating to de minimis emission increases)
- (5) Section 127.450 (relating to administrative operating permit amendments)

**SECTION B. General State Only Requirements**

(6) Section 127.462 (relating to minor operating permit modifications)

(7) Subchapter H (relating to general plan approvals and general operating permits)

#015 [25 Pa. Code § 127.11]**Reactivation**

(a) The permittee may not reactivate a source that has been out of operation or production for at least one year unless the reactivation is conducted in accordance with a plan approval granted by the Department or in accordance with reactivation and maintenance plans developed and approved by the Department in accordance with 25 Pa. Code § 127.11a(a).

(b) A source which has been out of operation or production for more than five (5) years but less than 10 years may be reactivated and will not be considered a new source if the permittee satisfies the conditions specified in 25 Pa. Code § 127.11a(b).

#016 [25 Pa. Code § 127.36]**Health Risk-based Emission Standards and Operating Practice Requirements.**

(a) When needed to protect public health, welfare and the environment from emissions of hazardous air pollutants from new and existing sources, the permittee shall comply with the health risk-based emission standards or operating practice requirements imposed by the Department, except as precluded by §§ 6.6(d)(2) and (3) of the Air Pollution Control Act [35 P.S. § 4006.6(d)(2) and (3)].

(b) A person challenging a performance or emission standard established by the Department has the burden to demonstrate that performance or emission standard does not meet the requirements of Section 112 of the Clean Air Act.

#017 [25 Pa. Code § 121.9]**Circumvention.**

No person may permit the use of a device, stack height which exceeds good engineering practice stack height, dispersion technique or other technique which, without resulting in reduction of the total amount of air contaminants emitted, conceals or dilutes an emission of air contaminants which would otherwise be in violation of 25 Pa. Code Article III, except that with prior approval of the Department, the device or technique may be used for control of malodors.

#018 [25 Pa. Code §§ 127.402(d) & 127.442]**Reporting Requirements.**

(a) The permittee shall comply with the applicable reporting requirements of the Clean Air Act, the regulations thereunder, the Air Pollution Control Act and 25 Pa. Code Article III including Chapters 127, 135 and 139.

(b) The permittee shall submit reports to the Department containing information the Department may prescribe relative to the operation and maintenance of any air contamination source.

(c) Reports, test data, monitoring data, notifications and requests for renewal of the permit shall be submitted to the:

Regional Air Program Manager
PA Department of Environmental Protection
(At the address given in the permit transmittal letter, or otherwise notified)

(d) Any records or information including applications, forms, or reports submitted pursuant to this permit condition shall contain a certification by a responsible official as to truth, accuracy and completeness. The certifications submitted under this permit shall require a responsible official of the facility to certify that based on information and belief formed after reasonable inquiry, the statements and information in the documents are true, accurate and complete.

(e) Any records, reports or information submitted to the Department shall be available to the public except for such

**SECTION B. General State Only Requirements**

records, reports or information which meet the confidentiality requirements of § 4013.2 of the Air Pollution Control Act and §§ 112(d) and 114(c) of the Clean Air Act. The permittee may not request a claim of confidentiality for any emissions data generated for the facility.

#019 [25 Pa. Code §§ 127.441(c) & 135.5]**Sampling, Testing and Monitoring Procedures.**

(a) The permittee shall comply with the monitoring, recordkeeping or reporting requirements of 25 Pa. Code Chapter 139 and the other applicable requirements of 25 Pa. Code Article III and additional requirements related to monitoring, reporting and recordkeeping required by the Clean Air Act and the regulations thereunder including the Compliance Assurance Monitoring requirements of 40 CFR Part 64, where applicable.

(b) Unless alternative methodology is required by the Clean Air Act and regulations adopted thereunder, sampling, testing and monitoring required by or used by the permittee to demonstrate compliance with any applicable regulation or permit condition shall be conducted in accordance with the requirements of 25 Pa. Code Chapter 139.

#020 [25 Pa. Code §§ 127.441(c) and 135.5]**Recordkeeping.**

(a) The permittee shall maintain and make available, upon request by the Department, the following records of monitored information:

- (1) The date, place (as defined in the permit) and time of sampling or measurements.
- (2) The dates the analyses were performed.
- (3) The company or entity that performed the analyses.
- (4) The analytical techniques or methods used.
- (5) The results of the analyses.
- (6) The operating conditions as existing at the time of sampling or measurement.

(b) The permittee shall retain records of any required monitoring data and supporting information for at least five (5) years from the date of the monitoring, sample, measurement, report or application. Supporting information includes the calibration data and maintenance records and original strip-chart recordings for continuous monitoring instrumentation, and copies of reports required by the permit.

(c) The permittee shall maintain and make available to the Department upon request, records including computerized records that may be necessary to comply with the reporting, recordkeeping and emission statement requirements in 25 Pa. Code Chapter 135 (relating to reporting of sources). In accordance with 25 Pa. Code Chapter 135, § 135.5, such records may include records of production, fuel usage, maintenance of production or pollution control equipment or other information determined by the Department to be necessary for identification and quantification of potential and actual air contaminant emissions.

#021 [25 Pa. Code § 127.441(a)]**Property Rights.**

This permit does not convey any property rights of any sort, or any exclusive privileges.

#022 [25 Pa. Code § 127.447]**Alternative Operating Scenarios.**

The permittee is authorized to make changes at the facility to implement alternative operating scenarios identified in this permit in accordance with 25 Pa. Code § 127.447.

**SECTION B. General State Only Requirements****#023 [25 Pa. Code §135.3]****Reporting**

(a) If the facility is a Synthetic Minor Facility, the permittee shall submit by March 1 of each year an annual emissions report for the preceding calendar year. The report shall include information for all active previously reported sources, new sources which were first operated during the preceding calendar year, and sources modified during the same period which were not previously reported. All air emissions from the facility should be estimated and reported.

(b) A source owner or operator of a Synthetic Minor Facility may request an extension of time from the Department for the filing of an annual emissions report, and the Department may grant the extension for reasonable cause.

#024 [25 Pa. Code §135.4]**Report Format**

If applicable, the emissions reports shall contain sufficient information to enable the Department to complete its emission inventory. Emissions reports shall be made by the source owner or operator in a format specified by the Department.

**SECTION C. Site Level Requirements****I. RESTRICTIONS.****Emission Restriction(s).****# 001 [25 Pa. Code §123.1]****Prohibition of certain fugitive emissions**

No person may permit the emission into the outdoor atmosphere of fugitive air contaminants from a source other than the following:

- (1) Construction or demolition of buildings or structures.
- (2) Grading, paving, and maintenance of roads and streets.
- (3) Use of roads and streets. Emissions from material in or on trucks, railroad cars, and other vehicular equipment are not considered as emissions from use of roads and streets.
- (4) Clearing of land.
- (5) Stockpiling of materials.
- (6) Open burning operations.
- (7) Sources and classes of sources other than those identified above, for which the permittee has obtained a determination from the Department that fugitive emissions from the source, after appropriate control, meet the following requirements:
 - (i) The emissions are of minor significance with respect to causing air pollution.
 - (ii) The emissions are not preventing or interfering with the attainment or maintenance of an ambient air quality standard.

002 [25 Pa. Code §123.2]**Fugitive particulate matter**

No person may permit fugitive particulate matter to be emitted into the outdoor atmosphere from a source specified in Condition #001(1)-(7) above if the emissions are visible at the point the emissions pass outside the person's property.

003 [25 Pa. Code §123.41]**Limitations**

No person may permit the emission into the outdoor atmosphere of visible air contaminants in such a manner that the opacity of the emission is either of the following:

- (1) Equal to or greater than 20% for a period or periods aggregating more than three minutes in any 1 hour.
- (2) Equal to or greater than 60% at any time.

004 [25 Pa. Code §123.42]**Exceptions**

The emission limitations of 25 Pa. Code Section 123.41 shall not apply when:

- (1) The presence of uncombined water is the only reason for failure of the emission to meet the limitations.
- (2) The emission results from the operation of equipment used solely to train and test persons in observing the opacity of visible emissions.
- (3) The emission results from sources specified in 25 Pa. Code Section 123.1(a)(1)-(9).

005 [25 Pa. Code §127.441]**Operating permit terms and conditions.**

[Additional authority for this condition is derived from the permittee volunteering to accept it as a restriction]

**SECTION C. Site Level Requirements**

(1) The total combined facility-wide emission of any single hazardous air pollutant shall not equal or exceed 10 tons in any 12 consecutive month period.

(2) The total combined facility-wide emission of all hazardous air pollutants shall not equal or exceed 25 tons in any 12 consecutive month period.

006 [25 Pa. Code §127.441]**Operating permit terms and conditions.**

[Additional authority for this permit condition is derived from 25 Pa. Code Sections 127.1, 127.12 and 129.91 through 129.95]

The total combined volatile organic compound emissions from all sources at this facility, including those emissions resulting from the use of cleanup solvents, shall not equal or exceed 50 tons in any 12 consecutive month period.

II. TESTING REQUIREMENTS.**# 007 [25 Pa. Code §139.1]****Sampling facilities.**

Upon the request of the Department, the permittee shall provide adequate sampling ports, safe sampling platforms, and adequate utilities for the performance by the Department of tests on such source. The Department will set forth, in the request, the time period in which the facilities shall be provided as well as the specifications for such facilities.

008 [25 Pa. Code §139.11]**General requirements.**

(a) As specified in 25 Pa. Code Section 139.11(1), performance tests shall be conducted while the source is operating at maximum routine operating conditions or under such other conditions, within the capacity of the equipment, as may be requested by the Department.

(b) As specified in 25 Pa. Code Section 139.11(2), the Department will consider test results for approval where sufficient information is provided to verify the source conditions existing at the time of the test and where adequate data is available to show the manner in which the test was conducted. Information submitted to the Department shall include, as a minimum, all of the following:

(1) A thorough source description, including a description of any air cleaning devices and the flue.

(2) Process conditions, for example, the charging rate of raw material or rate of production of final product, boiler pressure, oven temperature, and other conditions which may affect emissions from the process.

(3) The location of sampling ports.

(4) Effluent characteristics, including velocity, temperature, moisture content, gas density (percentage of CO, CO₂, O₂ and N₂), static and barometric pressures.

(5) Sample collection techniques employed, including procedures used, equipment descriptions, and data to verify that isokinetic sampling for particulate matter collection occurred and that acceptable test conditions were met.

(6) Laboratory procedures and results.

(7) Calculated results.

**SECTION C. Site Level Requirements****III. MONITORING REQUIREMENTS.****# 009 [25 Pa. Code §123.43]****Measuring techniques**

Visible emissions may be measured using either of the following:

- (1) A device approved by the Department and maintained to provide accurate opacity measurements.
- (2) Observers, trained and qualified to measure plume opacity with the naked eye or with the aid of any devices approved by the Department.

010 [25 Pa. Code §127.441]**Operating permit terms and conditions.**

(a) The permittee shall conduct a weekly inspection of the facility during daylight hours while the facility is operating to detect visible emissions, visible fugitive emissions, and malodors. Weekly inspections are necessary to determine:

- (1) The presence of visible emissions.
- (2) The presence of visible fugitive emissions.
- (3) The presence of malodors beyond the boundaries of the facility.

(b) All detected visible emissions, visible fugitive emissions, or malodors that have the potential to exceed applicable limits shall be reported to the manager of the facility.

IV. RECORDKEEPING REQUIREMENTS.**# 011 [25 Pa. Code §127.441]****Operating permit terms and conditions.**

(a) The permittee shall maintain a logbook of the facility's weekly inspections performed. The logbook shall include the name of the company representative performing the inspection, the date and time of inspections, any instances of exceedances of visible emissions limitations, visible fugitive emissions limitations, and malodorous air emissions limitations, and the name of the manager informed if a potential exceedance is observed. The permittee shall also record any and all corrective action(s) taken to abate each recorded deviation to prevent future occurrences.

(b) These records shall be retained for a minimum of five (5) years and shall be made available to the Department upon request.

012 [25 Pa. Code §127.441]**Operating permit terms and conditions.**

[Additional authority for the permit condition is derived from 25 Pa. Code Sections 127.1, 127.12 and 129.91 through 129.95]

The permittee shall maintain accurate and comprehensive records of the following:

- (1) All such records as are necessary to verify compliance with the facility-wide volatile organic compound emission limitation specified in condition #006 herein.
- (2) All such records as are necessary to verify compliance with the facility-wide hazardous air pollutant emission limitations specified in condition #005 herein.

All records generated pursuant to this condition shall be retained for at least five (5) years and shall be made available to the Department upon request.

013 [25 Pa. Code §127.441]**Operating permit terms and conditions.**

(a) The permittee shall keep records on a 12 consecutive month basis which contain the following information:

**SECTION C. Site Level Requirements**

- (1) The total combined amount of volatile organic compounds emitted from the facility during the previous 12 consecutive month period, as well as a copy of all supporting data and calculations.
- (2) The total combined amount of each hazardous air pollutant emitted from the facility during the previous 12 consecutive month period, as well as a copy of all supporting data and calculations.
- (3) The total combined amount of all hazardous air pollutants emitted from the facility during the previous 12 consecutive month period, as well as a copy of all supporting data and calculations.

(b) These records shall be retained for a minimum of five (5) years and shall be made available to the Department upon request.

014 [25 Pa. Code §135.5]**Recordkeeping**

The permittee shall maintain such records, including computerized records as may be necessary to comply with 25 Pa. Code Sections 135.3 and 135.21. These may include records of production, fuel usage, maintenance of production or pollution control equipment or other information determined by the Department to be necessary for identification and quantification of air contaminant emissions.

All records generated pursuant to this condition shall be retained for at least five (5) years and shall be made available to the Department upon request.

V. REPORTING REQUIREMENTS.**# 015 [25 Pa. Code §127.441]****Operating permit terms and conditions.**

Upon request by the Department, the permittee shall submit all requested reports in accordance with the Department's suggested format.

016 [25 Pa. Code §127.441]**Operating permit terms and conditions.**

The permittee shall submit semi-annual reports to the Department which contain the following information:

- (1) The total combined amount of volatile organic compounds emitted from the facility during the previous 12 consecutive month period, as well as a copy of all supporting data and calculations.
- (2) The total combined amount of each hazardous air pollutant emitted from the facility during the previous 12 consecutive month period, as well as a copy of all supporting data and calculations.
- (3) The total combined amount of all hazardous air pollutants emitted from the facility during the previous 12 consecutive month period, as well as a copy of all supporting data and calculations.

The semi-annual reports shall be submitted by no later than September 1 (for the immediately-preceding July 1 through June 30 twelve consecutive month period) and March 1 (for the immediately-preceding January 1 through December 31 twelve consecutive month period). Reports due by March 1 shall be submitted via the Department's electronic Air Emissions System (AES) reporting system through the online DEP GreenPort. Reports due by September 1 shall be submitted as a pdf file in a format acceptable to the Department through the DEP OnBase online document submittal system or by e-mail attachment to the Regional Air Program Manager.

017 [25 Pa. Code §127.442]**Reporting requirements.**

(a) The permittee shall report malfunctions, emergencies or incidents of excess emissions to the Department. A malfunction is any sudden, infrequent, and not reasonably preventable failure of air pollution control equipment, process equipment, or a process to operate in a normal or usual manner. An emergency is any situation arising from sudden and reasonably unforeseeable events beyond the control of the owner or operator of a facility which requires immediate corrective action to restore normal operation and which causes the emission source to exceed emissions, due to unavoidable increases in emissions attributable to the situation. An emergency shall not include situations caused by

**SECTION C. Site Level Requirements**

improperly designed equipment, lack of preventive maintenance, careless or improper operation, or operator error.

(b) When the malfunction, emergency or incident of excess emissions poses an imminent danger to the public health, safety, welfare, or environment, it shall be reported to the Department and the County Emergency Management Agency by telephone within one (1) hour after the discovery of the malfunction, emergency or incident of excess emissions. The owner or operator shall submit a written or emailed report of instances of such malfunctions, emergencies or incidents of excess emissions to the Department within three (3) business days of the telephone report.

(c) The report shall describe the following:

1. name, permit or authorization number, and location of the facility,
2. nature and cause of the malfunction, emergency or incident,
3. date and time when the malfunction, emergency or incident was first observed,
4. expected duration of excess emissions,
5. estimated rate of emissions,
6. corrective actions or preventative measures taken.

(d) Any malfunction, emergency or incident of excess emissions that is not subject to the notice requirements of paragraph (b) of this condition shall be reported to the Department by telephone within 24 hours (or by 4:00 PM of the next business day, whichever is later) of discovery and in writing or by e-mail within five (5) business days of discovery. The report shall contain the same information required by paragraph (c), and any permit specific malfunction reporting requirements.

(e) During an emergency an owner or operator may continue to operate the source at their discretion provided they submit justification for continued operation of a source during the emergency and follow all the notification and reporting requirements in accordance with paragraphs (b)-(d), as applicable, including any permit specific malfunction reporting requirements.

(f) Reports regarding malfunctions, emergencies or incidents of excess emissions shall be submitted to the appropriate DEP Regional Office Air Program Manager.

(g) Any emissions resulted from malfunction or emergency are to be reported in the annual emissions inventory report, if the annual emissions inventory report is required by permit or authorization.

018 [25 Pa. Code §135.3]**Reporting**

(1) A person who owns or operates a source to which 25 Pa. Code 135 applies, and who has previously been advised by the Department to submit an annual Air Information Management Systems (AIMS) report, shall submit by March 1 of each year an annual AIMS report for the preceding calendar year. The report shall include information for all previously reported sources, new sources which were first operated during the proceeding calendar year and sources modified during the same period which were not previously reported.

(2) A person who receives initial notification by the Department that an annual AIMS report is necessary shall submit an initial annual AIMS report within 60 days after receiving the notification or by March 1 of the year following the year for which the report is required, whichever is later.

(3) A source owner or operator may request an extension of time from the Department for the filing of an annual AIMS report, and the Department may grant the extension for reasonable cause.

VI. WORK PRACTICE REQUIREMENTS.**# 019 [25 Pa. Code §123.1]****Prohibition of certain fugitive emissions**

For any source specified in 25 Pa. Code Section 123.1 subsection(s) (a)(1)-(7) or (a)(9), the permittee shall take all reasonable actions to prevent particulate matter from becoming airborne. These actions shall include, but not be limited to, the following:

- (1) Use, where possible, of water or chemicals for control of dust in the demolition of buildings or structures, construction operations, the grading of roads, or the clearing of land.

**SECTION C. Site Level Requirements**

(2) Application of asphalt, oil, or suitable chemicals on dirt roads, material stockpiles, and other surfaces which may give rise to airborne dusts.

(3) Paving and maintenance of roadways.

(4) Prompt removal of earth or other material from paved streets onto which earth or other material has been transported by trucking or earth moving equipment, erosion by water, or other means.

020 [25 Pa. Code §127.441]**Operating permit terms and conditions.**

[Additional authority for this permit condition is derived from 25 Pa. Code Sections 127.1, 127.12 and 129.91 through 129.95]

Under no circumstances shall volatile organic compound-containing solvent be sprayed through a spray gun into the atmosphere or flushed through a coating line in a manner that promotes evaporative loss into the atmosphere. If spray guns, nozzles, tips, etc. are cleaned with a volatile organic compound-containing solvent, they shall be cleaned by soaking them in closed containers. If coating lines are cleaned with volatile organic compound-containing solvent, they shall be cleaned by flushing the solvent into a closed container. All containers of volatile organic compound-containing cleanup solvents shall be kept closed when not in actual use and all solvent-wet cleaning rags, etc. shall be stored in closed containers when not in actual use. Under no circumstances shall waste volatile organic compound-containing cleaning solvent be disposed of via evaporation or solvent-wet rags, etc. be treated or pre-treated prior to disposal or reuse by subjecting them to air drying or any other means of solvent removal which would cause volatile organic compound-containing solvent to be evaporated into the air.

VII. ADDITIONAL REQUIREMENTS.**# 021 [25 Pa. Code §121.7]****Prohibition of air pollution.**

No person may permit air pollution as that term is defined in the act [The Air Pollution Control Act (35 P.S. §§ 4001-4015)].

022 [25 Pa. Code §123.31]**Limitations**

No person may permit the emission into the outdoor atmosphere of any malodorous air contaminants from any source in a manner that the malodors are detectable outside the property of the person on whose land the source is being operated.

023 [25 Pa. Code §129.14]**Open burning operations**

No person may permit the open burning of material at this facility unless in accordance with 25 Pa. Code Section 129.14.

VIII. COMPLIANCE CERTIFICATION.

No additional compliance certifications exist except as provided in other sections of this permit including Section B (relating to State Only General Requirements).

IX. COMPLIANCE SCHEDULE.

No compliance milestones exist.

**SECTION D. Source Level Requirements**

Source ID: 031

Source Name: WEIL-MCLAIN BOILER

Source Capacity/Throughput:

**I. RESTRICTIONS.****Emission Restriction(s).**

001 [25 Pa. Code §123.22]

Combustion units

The permittee shall not permit the emission of sulfur oxides, expressed as SO₂, into the outdoor atmosphere from Source 031 in excess of the rate of 4 pounds per million Btu of heat input over any 1-hour period.

Fuel Restriction(s).

002 [25 Pa. Code §127.411]

Content of applications.

Source 031 shall only be fired on natural gas.

II. TESTING REQUIREMENTS.

No additional testing requirements exist except as provided in other sections of this permit including Section B (State Only General Requirements).

III. MONITORING REQUIREMENTS.

No additional monitoring requirements exist except as provided in other sections of this permit including Section B (State Only General Requirements).

IV. RECORDKEEPING REQUIREMENTS.

No additional record keeping requirements exist except as provided in other sections of this permit including Section B (State Only General Requirements).

V. REPORTING REQUIREMENTS.

No additional reporting requirements exist except as provided in other sections of this permit including Section B (State Only General Requirements).

VI. WORK PRACTICE REQUIREMENTS.

No additional work practice requirements exist except as provided in other sections of this permit including Section B (State Only General Requirements).

VII. ADDITIONAL REQUIREMENTS.

003 [25 Pa. Code §127.411]

Content of applications.

Source 031 is a 300,000 Btu per hour Weil-McLain model EQ 25-PIN natural gas-fired boiler.

**SECTION D. Source Level Requirements**

Source ID: 032

Source Name: KEWANEE BOILER

Source Capacity/Throughput:

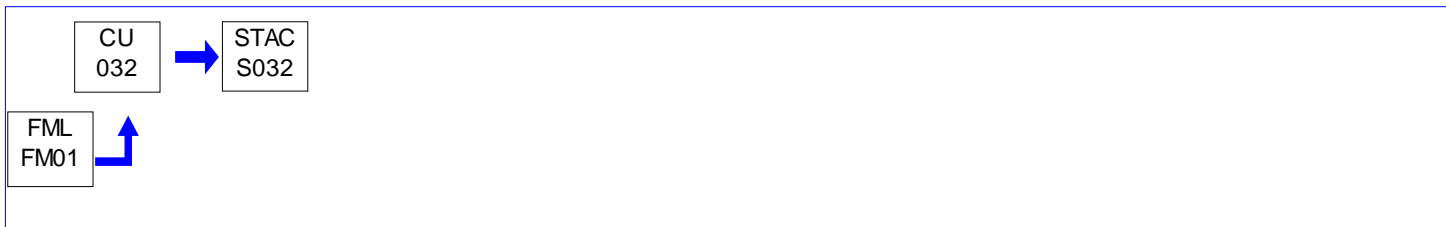
**I. RESTRICTIONS.****Emission Restriction(s).**

001 [25 Pa. Code §123.11]

Combustion units

The permittee shall not permit the emission into the outdoor atmosphere of particulate matter from Source 032 in excess of the rate of 0.4 pounds per million Btu of heat input.

002 [25 Pa. Code §123.22]

Combustion units

The permittee shall not permit the emission of sulfur oxides, expressed as SO₂, into the outdoor atmosphere from Source 032 in excess of the rate of 4 pounds per million Btu of heat input over any 1-hour period.

Fuel Restriction(s).

003 [25 Pa. Code §127.441]

Operating permit terms and conditions.

Source 032 shall only be fired on natural gas.

II. TESTING REQUIREMENTS.

No additional testing requirements exist except as provided in other sections of this permit including Section B (State Only General Requirements).

III. MONITORING REQUIREMENTS.

No additional monitoring requirements exist except as provided in other sections of this permit including Section B (State Only General Requirements).

IV. RECORDKEEPING REQUIREMENTS.

No additional record keeping requirements exist except as provided in other sections of this permit including Section B (State Only General Requirements).

V. REPORTING REQUIREMENTS.

No additional reporting requirements exist except as provided in other sections of this permit including Section B (State Only General Requirements).

VI. WORK PRACTICE REQUIREMENTS.

No additional work practice requirements exist except as provided in other sections of this permit including Section B (State Only General Requirements).

**SECTION D. Source Level Requirements****VII. ADDITIONAL REQUIREMENTS.****# 004 [25 Pa. Code §127.441]****Operating permit terms and conditions.**

Source 032 is a 4.25 million Btu per hour Kewanee model KFP30-962-G0 natural gas-fired boiler.

**SECTION D. Source Level Requirements**

Source ID: 033

Source Name: SPACE HEATERS

Source Capacity/Throughput:

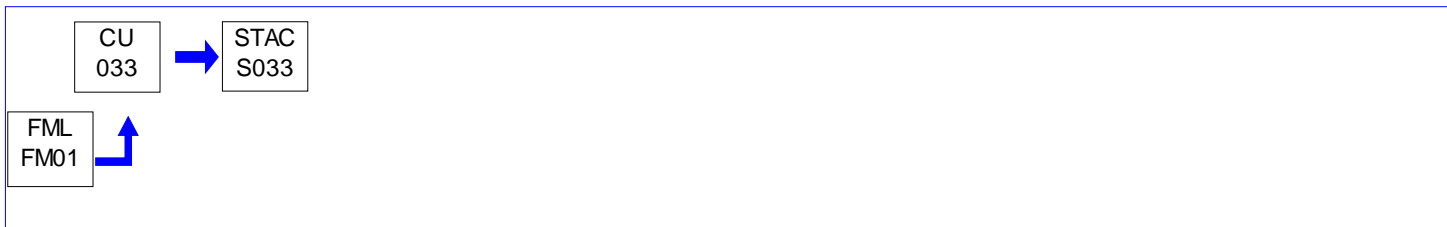
**I. RESTRICTIONS.****Emission Restriction(s).**

001 [25 Pa. Code §123.22]

Combustion units

The permittee shall not permit the emission of sulfur oxides, expressed as SO₂, into the outdoor atmosphere from the space heaters incorporated in Source 033 in excess of the rate of 4 pounds per million Btu of heat input over any 1-hour period.

II. TESTING REQUIREMENTS.

No additional testing requirements exist except as provided in other sections of this permit including Section B (State Only General Requirements).

III. MONITORING REQUIREMENTS.

No additional monitoring requirements exist except as provided in other sections of this permit including Section B (State Only General Requirements).

IV. RECORDKEEPING REQUIREMENTS.

No additional record keeping requirements exist except as provided in other sections of this permit including Section B (State Only General Requirements).

V. REPORTING REQUIREMENTS.

No additional reporting requirements exist except as provided in other sections of this permit including Section B (State Only General Requirements).

VI. WORK PRACTICE REQUIREMENTS.

No additional work practice requirements exist except as provided in other sections of this permit including Section B (State Only General Requirements).

VII. ADDITIONAL REQUIREMENTS.

002 [25 Pa. Code §127.441]

Operating permit terms and conditions.

Source 033 is comprised of the following combustion units:

- (a) eight (8) natural gas-fired space heaters, each 1.4087 MMBtu/hr, and
- (b) two (2) natural gas-fired space heaters, each 1.95762 MMBtu/hr.

**SECTION D. Source Level Requirements**

Source ID: P101

Source Name: SPRAY BOOTH 1

Source Capacity/Throughput:

Conditions for this source occur in the following groups: P101, P102 AND P103

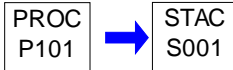
**I. RESTRICTIONS.****Emission Restriction(s).****# 001 [25 Pa. Code §123.13]****Processes**

The permittee shall not permit the emission into the outdoor atmosphere of particulate matter from Source P101 in such a manner that the concentration of particulate matter in the effluent gas exceeds 0.04 grains per dry standard cubic foot.

II. TESTING REQUIREMENTS.

No additional testing requirements exist except as provided in other sections of this permit including Section B (State Only General Requirements) and/or Section E (Source Group Restrictions).

III. MONITORING REQUIREMENTS.

No additional monitoring requirements exist except as provided in other sections of this permit including Section B (State Only General Requirements) and/or Section E (Source Group Restrictions).

IV. RECORDKEEPING REQUIREMENTS.**# 002 [25 Pa. Code §127.441]****Operating permit terms and conditions.**

[Additional authority for this permit condition is derived from 25 Pa. Code Section 129.95]

The permittee shall maintain documentation from the coating suppliers/manufacturers which certifies that all coatings (including strippable booth coatings) used in Source P101 are in compliance with their respective volatile organic compound content limitations. All records generated pursuant to this condition shall be retained for at least five (5) years and shall be made available to the Department upon request.

V. REPORTING REQUIREMENTS.

No additional reporting requirements exist except as provided in other sections of this permit including Section B (State Only General Requirements) and/or Section E (Source Group Restrictions).

VI. WORK PRACTICE REQUIREMENTS.

No additional work practice requirements exist except as provided in other sections of this permit including Section B (State Only General Requirements) and/or Section E (Source Group Restrictions).

VII. ADDITIONAL REQUIREMENTS.**# 003 [25 Pa. Code §127.441]****Operating permit terms and conditions.**

[Additional authority for this permit condition is derived from 25 Pa. Code Sections 129.91 through 129.95]

The volatile organic compound content of the coatings used in Source P101 (other than strippable booth coatings) shall not

**SECTION D. Source Level Requirements**

exceed 1.5 pounds of volatile organic compounds per gallon of coating, as applied.

004 [25 Pa. Code §127.441]**Operating permit terms and conditions.**

[Additional authority for this permit condition is derived from 25 Pa. Code Sections 129.91 through 129.95]

The volatile organic compound content of the strippable booth coatings used in Source P101 shall not exceed 1.2 pounds of volatile organic compounds per gallon of coating, as applied.

005 [25 Pa. Code §127.441]**Operating permit terms and conditions.**

Source P101 is a spray booth used for the application of finish coats and touch-up work.

**SECTION D. Source Level Requirements**

Source ID: P102

Source Name: SPRAY BOOTH 2

Source Capacity/Throughput:

Conditions for this source occur in the following groups: P101, P102 AND P103

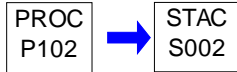
**I. RESTRICTIONS.****Emission Restriction(s).****# 001 [25 Pa. Code §123.13]****Processes**

The permittee shall not permit the emission into the outdoor atmosphere of particulate matter from Source P102 in such a manner that the concentration of particulate matter in the effluent gas exceeds 0.04 grains per dry standard cubic foot.

II. TESTING REQUIREMENTS.

No additional testing requirements exist except as provided in other sections of this permit including Section B (State Only General Requirements) and/or Section E (Source Group Restrictions).

III. MONITORING REQUIREMENTS.

No additional monitoring requirements exist except as provided in other sections of this permit including Section B (State Only General Requirements) and/or Section E (Source Group Restrictions).

IV. RECORDKEEPING REQUIREMENTS.**# 002 [25 Pa. Code §127.441]****Operating permit terms and conditions.**

[Additional authority for this permit condition is derived from 25 Pa. Code Section 129.95]

The permittee shall maintain documentation from the coating suppliers/manufacturers which certifies that all coatings (including strippable booth coatings) used in Source P102 are in compliance with their respective volatile organic compound content limitations. All records generated pursuant to this condition shall be retained for at least five (5) years and shall be made available to the Department upon request.

V. REPORTING REQUIREMENTS.

No additional reporting requirements exist except as provided in other sections of this permit including Section B (State Only General Requirements) and/or Section E (Source Group Restrictions).

VI. WORK PRACTICE REQUIREMENTS.

No additional work practice requirements exist except as provided in other sections of this permit including Section B (State Only General Requirements) and/or Section E (Source Group Restrictions).

VII. ADDITIONAL REQUIREMENTS.**# 003 [25 Pa. Code §127.441]****Operating permit terms and conditions.**

[Additional authority for this permit condition is derived from 25 Pa. Code Sections 129.91 through 129.95]

The volatile organic compound content of the coatings used in Source P102 (other than strippable booth coatings) shall not

**SECTION D. Source Level Requirements**

exceed 1.5 pounds of volatile organic compounds per gallon of coating, as applied.

004 [25 Pa. Code §127.441]**Operating permit terms and conditions.**

[Additional authority for this permit condition is derived from 25 Pa. Code Sections 129.91 through 129.95]

The volatile organic compound content of the strippable booth coatings used in Source P102 shall not exceed 1.2 pounds of volatile organic compounds per gallon of coating, as applied.

005 [25 Pa. Code §127.441]**Operating permit terms and conditions.**

Source P102 is a spray booth used for the application of finish coats and touch-up work.

**SECTION D. Source Level Requirements**

Source ID: P103

Source Name: SPRAY BOOTH 3

Source Capacity/Throughput:

Conditions for this source occur in the following groups: P101, P102 AND P103

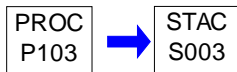
**I. RESTRICTIONS.****Emission Restriction(s).****# 001 [25 Pa. Code §123.13]****Processes**

The permittee shall not permit the emission into the outdoor atmosphere of particulate matter from Source P103 in such a manner that the concentration of particulate matter in the effluent gas exceeds 0.04 grains per dry standard cubic foot.

II. TESTING REQUIREMENTS.

No additional testing requirements exist except as provided in other sections of this permit including Section B (State Only General Requirements) and/or Section E (Source Group Restrictions).

III. MONITORING REQUIREMENTS.

No additional monitoring requirements exist except as provided in other sections of this permit including Section B (State Only General Requirements) and/or Section E (Source Group Restrictions).

IV. RECORDKEEPING REQUIREMENTS.**# 002 [25 Pa. Code §127.441]****Operating permit terms and conditions.**

[Additional authority for this permit condition is derived from 25 Pa. Code Section 129.95]

The permittee shall maintain documentation from the coating suppliers/manufacturers which certifies that all coatings (including strippable booth coatings) used in Source P103 are in compliance with their respective volatile organic compound content limitations. All records generated pursuant to this condition shall be retained for at least five (5) years and shall be made available to the Department upon request.

V. REPORTING REQUIREMENTS.

No additional reporting requirements exist except as provided in other sections of this permit including Section B (State Only General Requirements) and/or Section E (Source Group Restrictions).

VI. WORK PRACTICE REQUIREMENTS.

No additional work practice requirements exist except as provided in other sections of this permit including Section B (State Only General Requirements) and/or Section E (Source Group Restrictions).

VII. ADDITIONAL REQUIREMENTS.**# 003 [25 Pa. Code §127.441]****Operating permit terms and conditions.**

[Additional authority for this permit condition is derived from 25 Pa. Code Sections 129.91 through 129.95]

The volatile organic compound content of the coatings used in Source P103 (other than strippable booth coatings) shall not

**SECTION D. Source Level Requirements**

exceed 1.5 pounds of volatile organic compounds per gallon of coating, as applied.

004 [25 Pa. Code §127.441]**Operating permit terms and conditions.**

[Additional authority for this permit condition is derived from 25 Pa. Code Sections 129.91 through 129.95]

The volatile organic compound content of the strippable booth coatings used in Source P103 shall not exceed 1.2 pounds of volatile organic compounds per gallon of coating, as applied

005 [25 Pa. Code §127.441]**Operating permit terms and conditions.**

Source P103 is a spray booth used for the application of finish coats and touch-up work.

**SECTION D. Source Level Requirements**

Source ID: P105

Source Name: SPRAY BOOTH 4

Source Capacity/Throughput:

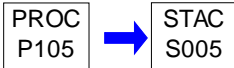
**I. RESTRICTIONS.****Emission Restriction(s).****# 001 [25 Pa. Code §123.13]****Processes**

The permittee shall not permit the emission into the outdoor atmosphere of particulate matter from Source P105 in such a manner that the concentration of particulate matter in the effluent gas exceeds 0.04 grains per dry standard cubic foot.

002 [25 Pa. Code §127.441]**Operating permit terms and conditions.**

[Additional authority for this permit condition is derived from 25 Pa. Code Sections 127.1 and 127.12]

The total combined volatile organic compound emissions from Source P105 shall not exceed 3.55 tons in any 12 consecutive month period nor shall the total combined volatile hazardous air pollutant emissions from Source P105 exceed 3.55 tons in any 12 consecutive month period (excluding any volatile organic compound or volatile hazardous air pollutant emissions resulting from the use of strippable booth coating).

Throughput Restriction(s).**# 003 [25 Pa. Code §127.441]****Operating permit terms and conditions.**

[Additional authority for this permit condition is derived from 25 Pa. Code Sections 127.1 and 127.12]

No more than 35 gallons of strippable booth coating shall be used in Source P105 in any 12 consecutive month period.

II. TESTING REQUIREMENTS.

No additional testing requirements exist except as provided in other sections of this permit including Section B (State Only General Requirements).

III. MONITORING REQUIREMENTS.

No additional monitoring requirements exist except as provided in other sections of this permit including Section B (State Only General Requirements).

IV. RECORDKEEPING REQUIREMENTS.**# 004 [25 Pa. Code §127.441]****Operating permit terms and conditions.**

The permittee shall maintain documentation from the coating suppliers/manufacturers which certifies that all coatings (including strippable booth coatings) used in Source P105 are in compliance with their respective volatile organic compound content limitations. All records generated pursuant to this condition shall be retained for at least five (5) years and shall be made available to the Department upon request.

005 [25 Pa. Code §127.441]**Operating permit terms and conditions.**

The permittee shall maintain the following records for the coatings (including strippable booth coatings) and cleanup solvents used in Source P105:

**SECTION D. Source Level Requirements**

- (1) The identity and amount of each individual coating, coating component and coating additive (other than water) used during each month.
- (2) If a coating applied in Source P105 is mixed onsite from multiple components or if a coating has an additive (other than water) mixed with it onsite, the identity of the coating components and/or additives and the mix ratio of these components and/or additives for each different batch of coating.
- (3) The density of each coating, coating component and coating additive (other than water) used.
- (4) The volatile organic compound content (percent, by weight) of each coating, coating component and coating additive (other than water) used.
- (5) The volatile hazardous air pollutant content (percent, by weight) of each coating, coating component and coating additive (other than water) used.
- (6) The solids content (percent, by volume) of each coating, coating component and coating additive (other than water) used.
- (7) The identity and amount of each cleanup solvent (other than water) used during each month, including acetone.

All records generated pursuant to this condition shall be retained for at least five (5) years and shall be made available to the Department upon request.

V. REPORTING REQUIREMENTS.

006 [25 Pa. Code §127.441]

Operating permit terms and conditions.

The permittee shall submit a report each year listing the following information for the coatings (including strippable booth coatings) and cleanup solvents used in Source P105:

- (1) The identity and amount of each individual coating, coating component and coating additive (other than water) used during each month of the prior year.
- (2) If a coating applied in Source P105 is mixed onsite from multiple components or if a coating has an additive (other than water) mixed with it onsite, the identity of the coating components and/or additives and the mix ratio of these components and/or additives for each different batch of coating.
- (3) The density of each coating, coating component and coating additive (other than water) used.
- (4) The volatile organic compound content (percent, by weight) of each coating, coating component and coating additive (other than water) used.
- (5) The volatile hazardous air pollutant content (percent, by weight) of each coating, coating component and coating additive (other than water) used.
- (6) The solids content (percent, by volume) of each coating, coating component and coating additive (other than water) used.
- (7) The identity and amount of each cleanup solvent (other than water) used during each month of the prior year, including acetone.

Each annual report shall be submitted to the Department by no later than March 1 of each calendar year (for the immediately-preceding January 1 through December 31 twelve consecutive month period) via the Department's electronic Air Emissions System (AES) reporting system through the online DEP GreenPort.

VI. WORK PRACTICE REQUIREMENTS.

No additional work practice requirements exist except as provided in other sections of this permit including Section B (State Only General Requirements).

VII. ADDITIONAL REQUIREMENTS.

007 [25 Pa. Code §127.441]

Operating permit terms and conditions.

[Additional authority for this permit condition is derived from 25 Pa. Code Sections 127.1 and 127.12]

The only coatings to be applied in Source P105 (other than strippable booth coatings) shall be water-based coatings with a maximum volatile organic compound content of 1.5 pounds per gallon of coating and a maximum volatile hazardous air pollutant content of 1.5 pounds per gallon of coating, as applied. Additionally, nothing may be added to these coatings to thin or reduce them other than water.

**SECTION D. Source Level Requirements****# 008 [25 Pa. Code §127.441]****Operating permit terms and conditions.**

[Additional authority for this permit condition is derived from 25 Pa. Code Sections 127.1 and 127.12]

The strippable booth coating used in Source P105 shall have a maximum volatile organic compound content of 1.2 pounds per gallon of coating and a maximum volatile hazardous air pollutant content of 0.1 pounds per gallon of coating, as applied.

009 [25 Pa. Code §127.441]**Operating permit terms and conditions.**

[Additional authority for this permit condition is derived from 25 Pa. Code Sections 127.1 and 127.12]

Volatile organic compound-containing and volatile hazardous air pollutant-containing materials shall not be used in Source P105 for cleanup activities. The permittee may, however, use acetone in Source P105 for cleanup activities.

010 [25 Pa. Code §127.441]**Operating permit terms and conditions.**

[Additional authority for this permit condition is derived from 25 Pa. Code Sections 127.1 and 127.12]

Source P105 shall be equipped with a full set of spray booth filters whenever in use.

011 [25 Pa. Code §127.441]**Operating permit terms and conditions.**

Source P105 is a spray booth used for the application of finish coats and touch-up work.

**SECTION D. Source Level Requirements**

Source ID: P106

Source Name: PREFINISH LINE

Source Capacity/Throughput:

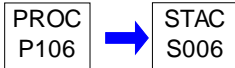
**I. RESTRICTIONS.****Emission Restriction(s).**

001 [25 Pa. Code §123.13]

Processes

The permittee shall not permit the emission into the outdoor atmosphere of particulate matter from Source P106 in such a manner that the concentration of particulate matter in the effluent gas exceeds 0.04 grains per dry standard cubic foot.

II. TESTING REQUIREMENTS.

No additional testing requirements exist except as provided in other sections of this permit including Section B (State Only General Requirements).

III. MONITORING REQUIREMENTS.

No additional monitoring requirements exist except as provided in other sections of this permit including Section B (State Only General Requirements).

IV. RECORDKEEPING REQUIREMENTS.

002 [25 Pa. Code §127.441]

Operating permit terms and conditions.

[Additional authority for this permit condition is derived from 25 Pa. Code Section 129.95]

The permittee shall maintain documentation from the coating suppliers/manufacturers which certifies that all coatings used in Source P106 are in compliance with their respective volatile organic compound content limitations. All records generated pursuant to this condition shall be retained for at least five (5) years and shall be made available to the Department upon request.

003 [25 Pa. Code §127.441]

Operating permit terms and conditions.

[Additional authority for this permit condition is derived from 25 Pa. Code Section 129.95]

The permittee shall maintain the following records for the coatings used in Source P106:

- (1) The identity and amount of each individual coating, coating component and coating additive (other than water) used during each month.
- (2) If a coating used in Source P106 is mixed onsite from multiple components or if a coating has an additive (other than water) mixed with it onsite, the identity of the coating components and/or additives and the mix ratio of these components and/or additives for each different batch of coating.
- (3) The density of each coating, coating component and coating additive (other than water) used.
- (4) The volatile organic compound content (percent, by weight) of each coating, coating component and coating additive (other than water) used.
- (5) The volatile hazardous air pollutant content (percent, by weight) of each coating, coating component and coating additive (other than water) used.
- (6) The solids content (percent, by volume) of each coating, coating component and coating additive (other than water) used.

All records generated pursuant to this condition shall be retained for at least five (5) years and shall be made available to the Department upon request.

**SECTION D. Source Level Requirements****V. REPORTING REQUIREMENTS.****# 004 [25 Pa. Code §127.441]****Operating permit terms and conditions.**

The permittee shall submit a report each year listing the following information for the coatings used in Source P106:

- (1) The identity and amount of each individual coating, coating component and coating additive (other than water) used during each month of the prior year.
- (2) If a coating used in Source P106 is mixed onsite from multiple components or if a coating has an additive (other than water) mixed with it onsite, the identity of the coating components and/or additives and the mix ratio of these components and/or additives for each different batch of coating.
- (3) The density of each coating, coating component and coating additive (other than water) used.
- (4) The volatile organic compound content (percent, by weight) of each coating, coating component and coating additive (other than water) used.
- (5) The volatile hazardous air pollutant content (percent, by weight) of each coating, coating component and coating additive (other than water) used.
- (6) The solids content (percent, by volume) of each coating, coating component and coating additive (other than water) used.

Each annual report shall be submitted to the Department by no later than March 1 of each calendar year (for the immediately-preceding January 1 through December 31 twelve consecutive month period) via the Department's electronic Air Emissions System (AES) reporting system through the online DEP GreenPort.

VI. WORK PRACTICE REQUIREMENTS.

No additional work practice requirements exist except as provided in other sections of this permit including Section B (State Only General Requirements).

VII. ADDITIONAL REQUIREMENTS.**# 005 [25 Pa. Code §127.441]****Operating permit terms and conditions.**

[Additional authority for this permit condition is derived from 25 Pa. Code Sections 127.1, 127.12 and 129.91 through 129.95]

The coatings used in Source P106 (other than UV topcoats) shall not exceed the following limitations as mixed (with tint pastes, dyes, "additives", thinners, reducers, etc.) for application:

- (1) Washcoats (611 series or equivalent) - 1.80 pounds of volatile organic compounds per gallon of coating.
- (2) Tiecoats (611 series or equivalent) - 0.10 pounds of volatile organic compounds per gallon of coating.
- (3) Sealers (611 series or equivalent) - 0.60 pounds of volatile organic compounds per gallon of coating.
- (4) Stains (621 series or equivalent) - 0.90 pounds of volatile organic compounds per gallon of coating.
- (5) Basecoats (631 series or equivalent) - 0.25 pounds of volatile organic compounds per gallon of coating.
- (6) Floodcoats (640, 641 series or equivalent) - 0.20 pounds of volatile organic compounds per gallon of coating.
- (7) Wipe stains (644 series or equivalent) - 3.00 pounds of volatile organic compounds per gallon of coating.
- (8) Primers (650 series or equivalent) - 0.30 pounds of volatile organic compounds per gallon of coating.
- (9) Waterbase topcoats (680 series or equivalent) - 1.60 pounds of volatile organic compounds per gallon of coating.
- (10) Inks (699 series or equivalent) - 0.70 pounds of volatile organic compounds per gallon of coating.
- (11) Wood protectant (730 series or equivalent) - 6.30 pounds of volatile organic compounds per gallon of coating.

006 [25 Pa. Code §127.441]**Operating permit terms and conditions.**

Source P106 is a Cella prefinishing line that applies coatings to doors and door components at the subject facility. Source P106 consists of nine (9) roller coaters and six (6) flash-off ovens.

007 [25 Pa. Code §127.441]**Operating permit terms and conditions.**

[Additional authority for this permit condition is derived from 25 Pa. Code Sections 127.1, 127.12 and 129.91 through 129.95]

**SECTION D. Source Level Requirements**

The UV topcoats used in Source P106 shall have a maximum theoretical volatile organic compound content of 0.13 pounds of volatile organic compounds per gallon of coating (based on the identities and quantities of the coating constituents mixed together to produce the coating) but may be shown by Method 24 analysis to have a volatile organic compound content of up to 0.68 pounds of volatile organic compounds per gallon of coating (including any photoinitiator which may be added).

**SECTION D. Source Level Requirements**

Source ID: P106A

Source Name: PREFINISH LINE ADDITION #1

Source Capacity/Throughput:

Conditions for this source occur in the following groups: P106A AND P112

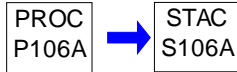
**I. RESTRICTIONS.****Emission Restriction(s).****# 001 [25 Pa. Code §123.13]****Processes**

The permittee shall not permit the emission into the outdoor atmosphere of particulate matter from Source P106A in such a manner that the concentration of particulate matter in the effluent gas exceeds 0.04 grains per dry standard cubic foot.

Throughput Restriction(s).**# 002 [25 Pa. Code §127.441]****Operating permit terms and conditions.**

[Additional authority for this permit condition is derived from 25 Pa. Code Sections 127.1 and 127.12]

No more than 20,500 gallons of coating and 256.25 gallons of photoinitiator may be used in Source P106A in any 12 consecutive month period.

II. TESTING REQUIREMENTS.

No additional testing requirements exist except as provided in other sections of this permit including Section B (State Only General Requirements) and/or Section E (Source Group Restrictions).

III. MONITORING REQUIREMENTS.

No additional monitoring requirements exist except as provided in other sections of this permit including Section B (State Only General Requirements) and/or Section E (Source Group Restrictions).

IV. RECORDKEEPING REQUIREMENTS.**# 003 [25 Pa. Code §127.441]****Operating permit terms and conditions.**

The permittee shall maintain documentation from the coating suppliers/manufacturers which certifies that all coatings used in Source P106A are in compliance with their respective volatile organic compound content limitations. All records generated pursuant to this condition shall be retained for at least five (5) years and shall be made available to the Department upon request.

004 [25 Pa. Code §127.441]**Operating permit terms and conditions.**

The permittee shall maintain the following records for the coatings and cleanup solvents used in Source P106A:

- (1) The identity and amount of each individual coating, coating component and coating additive (other than water) used during each month.
- (2) If a coating used in Source P106A is mixed onsite from multiple components or if a coating has an additive (other than water) mixed with it onsite, the identity of the coating components and/or additives and the mix ratio of these components and/or additives for each different batch of coating.
- (3) The density of each coating, coating component and coating additive (other than water) used.
- (4) The volatile organic compound content (percent, by weight) of each coating, coating component and coating additive

**SECTION D. Source Level Requirements**

(other than water) used.

(5) The volatile hazardous air pollutant content (percent, by weight) of each coating, coating component and coating additive (other than water) used.

(6) The solids content (percent, by volume) of each coating, coating component and coating additive (other than water) used.

(7) The identity and amount of each cleanup solvent (other than water) used during each month, including acetone.

All records generated pursuant to this condition shall be retained for at least five (5) years and shall be made available to the Department upon request.

V. REPORTING REQUIREMENTS.

005 [25 Pa. Code §127.441]

Operating permit terms and conditions.

The permittee shall submit a report each year listing the following information for the coatings and cleanup solvents used in Source P106A:

(1) The identity and amount of each individual coating, coating component and coating additive (other than water) used during each month of the prior year.

(2) If a coating used in Source P106A is mixed onsite from multiple components or if a coating has an additive (other than water) mixed with it onsite, the identity of the coating components and/or additives and the mix ratio of these components and/or additives for each different batch of coating.

(3) The density of each coating, coating component and coating additive (other than water) used.

(4) The volatile organic compound content (percent, by weight) of each coating, coating component and coating additive (other than water) used.

(5) The volatile hazardous air pollutant content (percent, by weight) of each coating, coating component and coating additive (other than water) used.

(6) The solids content (percent, by volume) of each coating, coating component and coating additive (other than water) used.

(7) The identity and amount of each cleanup solvent (other than water) used during each month of the prior year, including acetone.

Each annual report shall be submitted to the Department by no later than March 1 of each calendar year (for the immediately-preceding January 1 through December 31 twelve consecutive month period) via the Department's electronic Air Emissions System (AES) reporting system through the online DEP GreenPort.

VI. WORK PRACTICE REQUIREMENTS.

No additional work practice requirements exist except as provided in other sections of this permit including Section B (State Only General Requirements) and/or Section E (Source Group Restrictions).

VII. ADDITIONAL REQUIREMENTS.

006 [25 Pa. Code §127.441]

Operating permit terms and conditions.

[Additional authority for this permit condition is derived from 25 Pa. Code Sections 127.1 and 127.12]

All coating used in Source P106A shall have a maximum theoretical volatile organic compound content of 0.50% by weight (based on the identities and quantities of the coating constituents mixed together to produce the coating) but may be shown by Method 24 analysis to have a volatile organic compound content of up to 0.50 pounds of volatile organic compounds per gallon of coating (including any photoinitiator which may be added). The maximum theoretical volatile hazardous air pollutant content of the coating applied with Source P106A shall not exceed 0.3% by weight (based on the identities and quantities of the coating constituents mixed together to produce the coating).

007 [25 Pa. Code §127.441]

Operating permit terms and conditions.

[Additional authority for this permit condition is derived from 25 Pa. Code Sections 127.1 and 127.12]

**SECTION D. Source Level Requirements**

Nothing may be added to the coating used in Source P106A other than photoinitiator and that shall not be added to the coating in excess of 1.25% of the volume of the coating.

008 [25 Pa. Code §127.441]

Operating permit terms and conditions.

Source P106A consists of one (1) Buerkle model SLC 1300 roll coater, one (1) Buerkle model SALR 1300 roll coater and two (2) UV curing ovens. This equipment is incorporated into the facility's existing prefinish line (Source P106).

**SECTION D. Source Level Requirements**

Source ID: P107

Source Name: GLUING OPERATIONS

Source Capacity/Throughput:

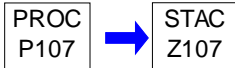
**I. RESTRICTIONS.**

No additional requirements exist except as provided in other sections of this permit including Section B (State Only General Requirements).

II. TESTING REQUIREMENTS.

No additional testing requirements exist except as provided in other sections of this permit including Section B (State Only General Requirements).

III. MONITORING REQUIREMENTS.

No additional monitoring requirements exist except as provided in other sections of this permit including Section B (State Only General Requirements).

IV. RECORDKEEPING REQUIREMENTS.**# 001 [25 Pa. Code §127.441]****Operating permit terms and conditions.**

The permittee shall maintain the following records for the glues used in Source P107:

- (1) The identity and amount of each individual volatile organic compound-containing and/or volatile hazardous air pollutant-containing glue used during each month.
- (2) The volatile organic compound content (percent, by weight) of each glue used.
- (3) The volatile hazardous air pollutant content (percent, by weight) of each glue used.

All records generated pursuant to this condition shall be retained for at least five (5) years and shall be made available to the Department upon request.

V. REPORTING REQUIREMENTS.**# 002 [25 Pa. Code §127.441]****Operating permit terms and conditions.**

The permittee shall submit a report each year listing the following information for the glues used in Source P107:

- (1) The identity and amount of each individual volatile organic compound-containing and/or volatile hazardous air pollutant-containing glue used during each month of the prior year.
- (2) The volatile organic compound content (percent, by weight) of each glue used.
- (3) The volatile hazardous air pollutant content (percent, by weight) of each glue used.

Each annual report shall be submitted to the Department by no later than March 1 of each calendar year (for the immediately-preceding January 1 through December 31 twelve consecutive month period) via the Department's electronic Air Emissions System (AES) reporting system through the online DEP GreenPort.

VI. WORK PRACTICE REQUIREMENTS.**# 003 [25 Pa. Code §129.77.]****Control of emissions from the use or application of adhesives, sealants, primers and solvents.**

[Additional authority for this permit condition is derived from 129.77(h)]

**SECTION D. Source Level Requirements**

The permittee shall store or dispose of all absorbent materials, including cloth or paper, which are moistened with adhesives, in nonabsorbent containers at the facility that are kept closed except when placing materials in or removing materials from the container.

VII. ADDITIONAL REQUIREMENTS.

004 [25 Pa. Code §127.441]

Operating permit terms and conditions.

Source P107 is a gluing operation associated with the assembly of door components.

005 [25 Pa. Code §129.77.]

Control of emissions from the use or application of adhesives, sealants, primers and solvents.

Source ID P107 (Gluing operations) is subject to the requirements of 25 Pa. Code Section 129.77. The permittee shall comply with all applicable requirements of 25 Pa. Code Section 129.77.

006 [25 Pa. Code §129.77.]

Control of emissions from the use or application of adhesives, sealants, primers and solvents.

[Additional authority for this permit condition is derived from 129.77(b)]

The permittee shall not use or apply an adhesive in gluing operation of Source ID P107 that exceeds the VOC content of 120 grams VOC per liter (less water and exempt compounds).

**SECTION D. Source Level Requirements**

Source ID: P108

Source Name: MILLING AND SANDING OPERATIONS

Source Capacity/Throughput:

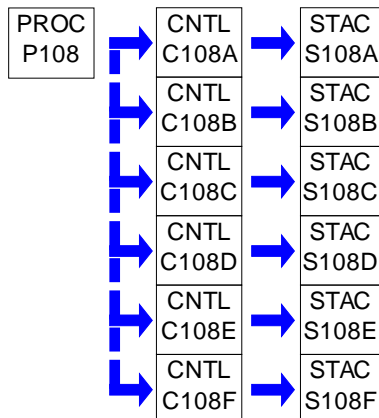
**I. RESTRICTIONS.****Emission Restriction(s).****# 001 [25 Pa. Code §127.441]****Operating permit terms and conditions.**

The permittee shall not permit the emission of particulate matter into the outdoor atmosphere from Source P108 in such a manner that the concentration of particulate matter in the effluent gas from any of the fabric collectors controlling Source P108 exceeds 0.01 grains per dry standard cubic foot.

Compliance with this condition also ensures compliance with 25 Pa. Code Section 123.13.

Operation Hours Restriction(s).**# 002 [25 Pa. Code §127.441]****Operating permit terms and conditions.**

Each of the fabric collectors controlling the particulate matter emissions from Source P108 shall not be exhausted to the outdoor atmosphere more than 2,000 hours in any 12 consecutive month period.

II. TESTING REQUIREMENTS.

No additional testing requirements exist except as provided in other sections of this permit including Section B (State Only General Requirements).

III. MONITORING REQUIREMENTS.**# 003 [25 Pa. Code §127.441]****Operating permit terms and conditions.**

Each fabric collector controlling the particulate matter emissions from Source P108 shall be equipped with instrumentation to continuously monitor the differential pressure across the respective collector.

IV. RECORDKEEPING REQUIREMENTS.**# 004 [25 Pa. Code §127.441]****Operating permit terms and conditions.**

The permittee shall maintain accurate and comprehensive records of the number of hours each fabric collector controlling the particulate matter emissions from Source P108 is vented to the outdoor atmosphere for each month. All records generated pursuant to this condition shall be retained for a minimum of five (5) years and shall be made available to the Department upon request.

**SECTION D. Source Level Requirements****V. REPORTING REQUIREMENTS.****# 005 [25 Pa. Code §127.441]****Operating permit terms and conditions.**

The permittee shall submit an annual report of the number of hours each fabric collector controlling the particulate matter emissions from Source P108 is vented to the outdoor atmosphere for each month during the previous calendar year (Records may be combined for fabric collectors which operate simultaneously).

Each annual report shall be submitted to the Department by no later than March 1 of each calendar year (for the immediately-preceding January 1 through December 31 twelve consecutive month period) via the Department's electronic Air Emissions System (AES) reporting system through the online DEP GreenPort.

VI. WORK PRACTICE REQUIREMENTS.**# 006 [25 Pa. Code §127.441]****Operating permit terms and conditions.**

Source P108 shall only be used to process kiln-dried wood and wood products. At no time shall Source P108 be used to process wood that has been treated with a wood preservative of any kind.

007 [25 Pa. Code §127.441]**Operating permit terms and conditions.**

The compressed air system associated with the fabric collectors controlling the particulate matter emissions from Source P108 shall be equipped with an air dryer and an oil trap.

008 [25 Pa. Code §127.441]**Operating permit terms and conditions.**

The permittee shall keep on hand a sufficient quantity of spare fabric collector bags for the fabric collectors in order to be able to immediately replace any bags requiring replacement due to deterioration resulting from routine operation of Source P108 and the associated fabric collectors.

VII. ADDITIONAL REQUIREMENTS.**# 009 [25 Pa. Code §127.441]****Operating permit terms and conditions.**

Source P108 is comprised of woodworking equipment utilized in the milling and sanding of wood doors and wood door components, the particulate matter emissions from which are controlled by a Scientific Collector model SPJ 408 X4T8 pulse jet type collector (Control Device C108A), a Scientific Collector model SPJ 84 X4T8 pulse jet type collector (Control Device C108B), a Scientific Collector model SPJ 192 X4T8 pulse jet type collector (Control Device C108C), a Scientific Collector model SPJ 264 X4T8 pulse jet type collector (Control Device C108D), a Scientific Collector model SPJ 258 X4T8 pulse jet type collector (Control Device C108E) and an Airlanco Collector model 188RLP10 type collector (Control Device C108F).

**SECTION D. Source Level Requirements**

Source ID: P109

Source Name: CLEANUP OPERATIONS

Source Capacity/Throughput:

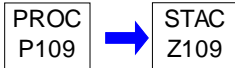
**I. RESTRICTIONS.**

No additional requirements exist except as provided in other sections of this permit including Section B (State Only General Requirements).

II. TESTING REQUIREMENTS.

No additional testing requirements exist except as provided in other sections of this permit including Section B (State Only General Requirements).

III. MONITORING REQUIREMENTS.

No additional monitoring requirements exist except as provided in other sections of this permit including Section B (State Only General Requirements).

IV. RECORDKEEPING REQUIREMENTS.**# 001 [25 Pa. Code §127.441]****Operating permit terms and conditions.**

[Additional authority for this permit condition is derived from 25 Pa. Code Sections 129.95]

The permittee shall maintain the following records for the cleanup solvents used in Source P109:

- (1) The identity and amount of each cleanup solvent (other than water) used during each month, including acetone.
- (2) The identity and amount of spent cleanup solvent (other than water) sent offsite in liquid form during each month, including acetone.

All records generated pursuant to this condition shall be retained for at least five (5) years and shall be made available to the Department upon request.

V. REPORTING REQUIREMENTS.**# 002 [25 Pa. Code §127.441]****Operating permit terms and conditions.**

The permittee shall submit a report each year listing the following information for the cleanup solvents used in Source P109:

- (1) The identity and amount of each cleanup solvent (other than water) used during each month of the prior year, including acetone.
- (2) The identity and amount of spent cleanup solvent (other than water) sent offsite in liquid form during each month of the prior year, including acetone.

Each annual report shall be submitted to the Department by no later than March 1 of each calendar year (for the immediately-preceding January 1 through December 31 twelve consecutive month period) via the Department's electronic Air Emissions System (AES) reporting system through the online DEP GreenPort.

VI. WORK PRACTICE REQUIREMENTS.

No additional work practice requirements exist except as provided in other sections of this permit including Section B (State Only General Requirements).

**SECTION D. Source Level Requirements****VII. ADDITIONAL REQUIREMENTS.****# 003 [25 Pa. Code §127.441]****Operating permit terms and conditions.**

Source P109 consists of cleanup operations and associated cleanup solvent usage at the facility, including cleanup solvent used in Source P105 and cleanup solvent used for cleanup activities associated with Sources P106A and P112.

**SECTION D. Source Level Requirements**

Source ID: P111

Source Name: EMERGENCY GENERATOR

Source Capacity/Throughput:

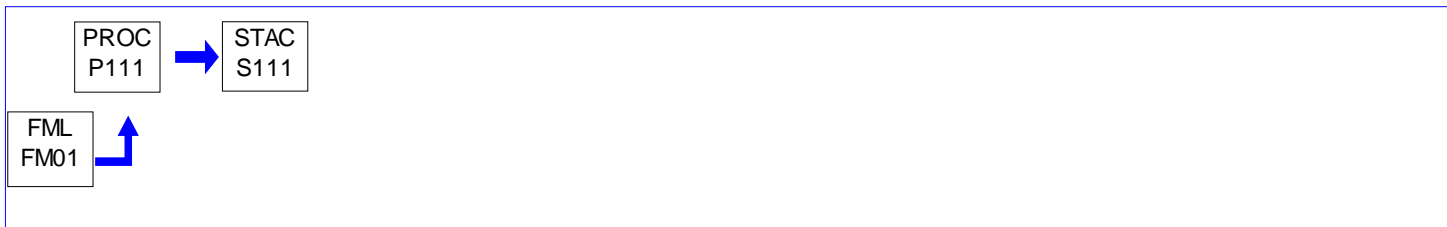
**I. RESTRICTIONS.****Emission Restriction(s).**

001 [25 Pa. Code §123.13]

Processes

The permittee shall not permit the emission into the outdoor atmosphere of particulate matter from Source P111 in such a manner that the concentration of particulate matter in the effluent gas exceeds 0.04 grains per dry standard cubic foot.

002 [25 Pa. Code §123.21]

General

The permittee shall not permit the emission of sulfur oxides into the outdoor atmosphere from Source P111 in such a manner that the concentration of the sulfur oxides, expressed as SO₂, in the effluent gas exceeds 500 parts per million, by volume, dry basis.

Operation Hours Restriction(s).

003 [25 Pa. Code §127.441]

Operating permit terms and conditions.

Source ID P111 shall not be operated 500 hours or more in any 12 consecutive month period.

004 [25 Pa. Code §127.441]

Operating permit terms and conditions.

[Additional authority for this permit condition is derived from 40 CFR Part 63, Section 63.6640(f)]

For engine of Source ID P111, the permittee shall limit combined maintenance/testing and non-emergency hours of operation to 100 hrs/yr, and limit non-emergency hours of operation to 50 hrs/yr as per Section 63.6640(f).

II. TESTING REQUIREMENTS.

No additional testing requirements exist except as provided in other sections of this permit including Section B (State Only General Requirements).

III. MONITORING REQUIREMENTS.

No additional monitoring requirements exist except as provided in other sections of this permit including Section B (State Only General Requirements).

IV. RECORDKEEPING REQUIREMENTS.

005 [25 Pa. Code §127.441]

Operating permit terms and conditions.

The permittee shall keep records of the number of hours that Source ID P111 is operated during each month. All records generated pursuant to this condition shall be retained for at least five (5) years and shall be made available to the Department upon request.

**SECTION D. Source Level Requirements****# 006 [25 Pa. Code §127.441]****Operating permit terms and conditions.**

[Additional authority for this permit condition is derived from 40 CFR Part 63, Sections 63.6655 and 63.6660]

The permittee shall maintain records of maintenance as well as records of hours of operation in emergency and non-emergency use through the non-resettable hour meter as per 40 CFR Part 63, Sections 63.6655 and 63.6660.

V. REPORTING REQUIREMENTS.**# 007 [25 Pa. Code §127.441]****Operating permit terms and conditions.**

The permittee shall submit a report each year listing the number of hours that Source ID P111 operated during each month of the prior year.

Each annual report shall be submitted to the Department by no later than March 1 of each calendar year (for the immediately-preceding January 1 through December 31 twelve consecutive month period) via the Department's electronic Air Emissions System (AES) reporting system through the online DEP GreenPort.

VI. WORK PRACTICE REQUIREMENTS.**# 008 [25 Pa. Code §127.441]****Operating permit terms and conditions.**

[Additional authority for this permit condition is derived from 40 CFR Part 63, Sections 63.6625]

(a) The permittee shall operate and maintain the engine of Source ID P111 as per manufacturer emissions-related written instructions or develop own maintenance plan consistent with good air pollution control practice for minimizing emissions as per Section 63.6625(e).

(b) The permittee shall install a non-resettable hour meter if one is not already installed as per Section 63.6625(f).

(c) The permittee shall minimize idle time of engine during startup and minimize startup time, not to exceed 30 minutes as per Section 63.6625(h).

009 [25 Pa. Code §127.441]**Operating permit terms and conditions.**

[Additional authority for this permit condition is derived from 40 CFR Part 63, Sections 63.6603(a)]

The permittee shall change oil and filter every 500 hours of operation or annually, whichever comes first, and replace as necessary; Inspect spark plugs every 1,000 hours of operation or annually, whichever comes first, and replace as necessary; Inspect all hoses and belts every 500 hours of operation or annually, whichever comes first, and replace as necessary as per Section 63.6603(a).

010 [25 Pa. Code §127.441]**Operating permit terms and conditions.**

[Additional authority for this permit condition is derived from 40 CFR Part 63, Sections 63.6605(b)]

The permittee shall operate and maintain equipment in a manner consistent with safety and good air pollution control practices for minimizing emissions as per Section 63.6605(b).

VII. ADDITIONAL REQUIREMENTS.**# 011 [25 Pa. Code §127.441]****Operating permit terms and conditions.**

Source ID P111 is a 5.0 kilowatt Pincor model EL 5000 SDVA emergency generator equipped with an 18.2 horsepower,

**SECTION D. Source Level Requirements**

natural gas-fired Wisconsin model THD3 engine.

012 [40 CFR Part 63 NESHAPS for Source Categories §40 CFR 63.6585]

Subpart ZZZZ - National Emissions Standards for Hazardous Air Pollutants for Stationary Reciprocating Internal Combustion Engines

Am I subject to this subpart?

Emergency generator of Source ID P111 is subject requirements of 40 CFR Part 63, Subpart ZZZZ, Sections 63.6580 through 63.6675. The permittee shall comply with all applicable requirements of 40 CFR Part 63, Subpart ZZZZ.

**SECTION D. Source Level Requirements**

Source ID: P112

Source Name: SPRAY BOOTH 5

Source Capacity/Throughput:

Conditions for this source occur in the following groups: P106A AND P112

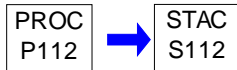
**I. RESTRICTIONS.****Emission Restriction(s).****# 001 [25 Pa. Code §123.13]****Processes**

The permittee shall not permit the emission into the outdoor atmosphere of particulate matter from Source P112 in such a manner that the concentration of particulate matter in the effluent gas exceeds 0.04 grains per dry standard cubic foot.

002 [25 Pa. Code §127.441]**Operating permit terms and conditions.**

[Additional authority for this condition is derived from the permittee volunteering to accept it as a restriction]

The emission of volatile hazardous air pollutants shall not exceed 0.30 tons in any 12 consecutive month period.

Throughput Restriction(s).**# 003 [25 Pa. Code §127.441]****Operating permit terms and conditions.**

[Additional authority for this permit condition is derived from 25 Pa. Code Sections 127.1 and 127.12]

No more than 12,220 gallons of coating shall be applied in Source P112 in any 12 consecutive month period (not counting strippable booth coating).

004 [25 Pa. Code §127.441]**Operating permit terms and conditions.**

[Additional authority for this permit condition is derived from 25 Pa. Code Sections 127.1 and 127.12]

No more than 35 gallons of strippable booth coating shall be used in Source P112 in any 12 consecutive month period.

II. TESTING REQUIREMENTS.

No additional testing requirements exist except as provided in other sections of this permit including Section B (State Only General Requirements) and/or Section E (Source Group Restrictions).

III. MONITORING REQUIREMENTS.

No additional monitoring requirements exist except as provided in other sections of this permit including Section B (State Only General Requirements) and/or Section E (Source Group Restrictions).

IV. RECORDKEEPING REQUIREMENTS.**# 005 [25 Pa. Code §127.441]****Operating permit terms and conditions.**

The permittee shall maintain the following records for the coatings (including strippable booth coatings) and cleanup solvents used in Source P112:

(1) The identity and amount of each individual coating, coating component and coating additive (other than water) used during each month.

**SECTION D. Source Level Requirements**

- (2) If a coating applied in Source P112 is mixed onsite from multiple components or if a coating has an additive (other than water) mixed with it onsite, the identity of the coating components and/or additives and the mix ratio of these components and/or additives for each different batch of coating.
- (3) The density of each coating, coating component and coating additive (other than water) used.
- (4) The volatile organic compound content (percent, by weight) of each coating, coating component and coating additive (other than water) used.
- (5) The volatile hazardous air pollutant content (percent, by weight) of each coating, coating component and coating additive (other than water) used.
- (6) The solids content (percent, by volume) of each coating, coating component and coating additive (other than water) used.
- (7) The identity and amount of each cleanup solvent (other than water) used during each month, including acetone.

All records generated pursuant to this condition shall be retained for at least five (5) years and shall be made available to the Department upon request.

006 [25 Pa. Code §127.441]**Operating permit terms and conditions.**

The permittee shall maintain documentation from the coating suppliers/manufacturers which certifies that all coatings (including strippable booth coatings) used in Source P112 are in compliance with their respective volatile organic compound and volatile hazardous air pollutant content limitations. All records generated pursuant to this condition shall be retained for at least five (5) years and shall be made available to the Department upon request.

V. REPORTING REQUIREMENTS.**# 007 [25 Pa. Code §127.441]****Operating permit terms and conditions.**

The permittee shall submit a report each year listing the following information for the coatings (including strippable booth coatings) and cleanup solvents used in Source P112:

- (1) The identity and amount of each individual coating, coating component and coating additive (other than water) used during each month of the prior year.
- (2) If a coating applied in Source P112 is mixed onsite from multiple components or if a coating has an additive (other than water) mixed with it onsite, the identity of the coating components and/or additives and the mix ratio of these components and/or additives for each different batch of coating.
- (3) The density of each coating, coating component and coating additive (other than water) used.
- (4) The volatile organic compound content (percent, by weight) of each coating, coating component and coating additive (other than water) used.
- (5) The volatile hazardous air pollutant content (percent, by weight) of each coating, coating component and coating additive (other than water) used.
- (6) The solids content (percent, by volume) of each coating, coating component and coating additive (other than water) used.
- (7) The identity and amount of each cleanup solvent (other than water) used during each month of the prior year, including acetone.

Each annual report shall be submitted to the Department by no later than March 1 of each calendar year (for the immediately-preceding January 1 through December 31 twelve consecutive month period) via the Department's electronic Air Emissions System (AES) reporting system through the online DEP GreenPort.

VI. WORK PRACTICE REQUIREMENTS.

No additional work practice requirements exist except as provided in other sections of this permit including Section B (State Only General Requirements) and/or Section E (Source Group Restrictions).

VII. ADDITIONAL REQUIREMENTS.**# 008 [25 Pa. Code §127.441]****Operating permit terms and conditions.**

[Additional authority for this permit condition is derived from 25 Pa. Code Sections 127.1 and 127.12]

**SECTION D. Source Level Requirements**

The only coatings to be applied in Source P112 (other than strippable booth coatings) shall be water-based coatings with a maximum volatile organic compound content of 1.5 pounds per gallon of coating and a maximum volatile hazardous air pollutant content of 1.5 pounds per gallon of coating, as applied. Additionally, nothing may be added to these coatings to thin or reduce them other than ammonia or water.

009 [25 Pa. Code §127.441]**Operating permit terms and conditions.**

Source P112 is a spray booth used for the application of finish coats to wood doors and door components and for touch-up work.

010 [25 Pa. Code §127.441]**Operating permit terms and conditions.**

[Additional authority for this permit condition is derived from 25 Pa. Code Sections 127.1 and 127.12]

Source P112 shall be equipped with a full set of spray booth filters whenever in use.

011 [25 Pa. Code §127.441]**Operating permit terms and conditions.**

[Additional authority for this permit condition is derived from 25 Pa. Code Sections 127.1 and 127.12]

The strippable booth coating used in Source P112 shall have a maximum volatile organic compound content of 1.2 pounds per gallon of coating and a maximum volatile hazardous air pollutant content of 0.1 pounds per gallon of coating, as applied.

**SECTION D. Source Level Requirements**

Source ID: P113

Source Name: PARTS CLEANER

Source Capacity/Throughput:

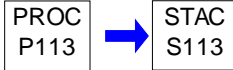
**I. RESTRICTIONS.**

No additional requirements exist except as provided in other sections of this permit including Section B (State Only General Requirements).

II. TESTING REQUIREMENTS.

No additional testing requirements exist except as provided in other sections of this permit including Section B (State Only General Requirements).

III. MONITORING REQUIREMENTS.

No additional monitoring requirements exist except as provided in other sections of this permit including Section B (State Only General Requirements).

IV. RECORDKEEPING REQUIREMENTS.**# 001 [25 Pa. Code §129.63]****Degreasing operations**

The permittee shall maintain accurate and comprehensive records of the following:

- (1) The name(s) and address(s) of the supplier(s) of the solvent(s) used in Source P113.
- (2) The type of solvent(s) used in Source P113 including the product or vendor identification number(s).
- (3) The vapor pressure(s) of the solvent(s) used in Source P113 measured in millimeters of mercury (mm Hg) at 20°C (68°F).

All records generated pursuant to this condition shall be retained at least two (2) years and shall be made available to the Department upon request. An invoice, bill of sale, certificate that corresponds to a number of sales, Material Safety Data Sheet (MSDS), or other appropriate documentation acceptable to the Department may be used to comply with this section.

V. REPORTING REQUIREMENTS.

No additional reporting requirements exist except as provided in other sections of this permit including Section B (State Only General Requirements).

VI. WORK PRACTICE REQUIREMENTS.**# 002 [25 Pa. Code §127.441]****Operating permit terms and conditions.**

Solvents containing hazardous air pollutants as an intentionally-added ingredient shall not be used in Source P113.

003 [25 Pa. Code §129.63]**Degreasing operations**

Solvents with a vapor pressure of 1.0 millimeter of mercury (mm Hg) or greater, measured at 20°C (68°F), shall not be used in Source P113.

004 [25 Pa. Code §129.63]**Degreasing operations**

Source P113 shall be operated in accordance with the following procedures:

**SECTION D. Source Level Requirements**

- (1) Waste solvent shall be collected and stored in closed containers. The closed containers may contain a device that allows pressure relief, but does not allow liquid solvent to drain from the container.
- (2) Flushing of parts using a flexible hose or other flushing device shall be performed only within the cold cleaning machine. The solvent spray shall be a solid fluid stream, not an atomized or shower spray.
- (3) Sponges, fabric, wood, leather, paper products and other absorbent materials may not be cleaned in the cold cleaning machine.
- (4) Air agitated solvent baths may not be used.
- (5) Spills during solvent transfer and use of the cold cleaning machine shall be cleaned up immediately.

005 [25 Pa. Code §129.63]**Degreasing operations**

Source P113 shall be equipped with a cover that shall be closed at all times except during the cleaning of parts or the addition or removal of solvent. A perforated drain with a diameter of not more than six inches shall be considered an acceptable cover.

006 [25 Pa. Code §129.63]**Degreasing operations**

Source P113 shall have a permanent, conspicuous label summarizing the operating requirements specified in condition #004 herein. In addition, the label shall also list the following discretionary good operating practices:

- (1) Cleaned parts should be drained at least 15 seconds or until dripping ceases, whichever is longer. Parts having cavities or blind holes shall be tipped or rotated while the part is draining. During the draining, tipping or rotating, the parts should be positioned so that solvent drains directly back to the cold cleaning machine.
- (2) When a pump-agitated solvent bath is used, the agitator should be operated to produce a rolling motion of the solvent with no observable splashing of the solvent against the tank walls or the parts being cleaned.
- (3) Work area fans should be located and positioned so that they do not blow across the opening of the degreaser unit.

VII. ADDITIONAL REQUIREMENTS.**# 007 [25 Pa. Code §127.441]****Operating permit terms and conditions.**

Source P113 is a Graymills model DMD236 remote reservoir parts cleaner.

**SECTION D. Source Level Requirements**

Source ID: P114

Source Name: SPRAY BOOTH #6

Source Capacity/Throughput:

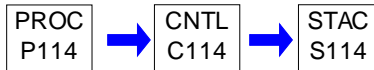
**I. RESTRICTIONS.****Emission Restriction(s).****# 001 [25 Pa. Code §127.441]****Operating permit terms and conditions.**

[Additional authority for this permit condition is derived from 25 Pa. Code Sections 127.1 and 127.12]

{Compliance with this permit condition assures compliance with the particulate matter emissions limitation of 25 Pa. Code Section 123.13}

The concentration of particulate matter emissions from the exhaust associated with the spray booth of Source ID P114 shall not exceed 0.01 grains per dry standard cubic feet at any time.

002 [25 Pa. Code §127.441]**Operating permit terms and conditions.**

[Additional authority for this permit condition is derived from 25 Pa. Code Sections 127.1 and 127.12]

(a) The total volatile organic compounds emissions from the spray booth of Source ID P114 shall not exceed 9.86 tons in any 12 consecutive month period.

(b) The total combined hazardous air pollutants emissions from the spray booth of Source ID P114 shall not exceed 0.31 tons in any 12 consecutive month period.

003 [25 Pa. Code §127.441]**Operating permit terms and conditions.**

[Additional authority for this permit condition is derived from 25 Pa. Code Sections 127.1 and 127.12]

(1) The volatile organic compound content of the primer used in the spray booth of Source ID P114 shall not exceed 0.024 pounds of volatile organic compounds per pound of coating solids, as mixed for application. The Department shall be notified for use of any alternate coating material having equal or lower VOC content in Source ID P114 other than previously approved by the Department.

(2) The volatile organic compound content of the enamel used in Source ID P114 shall not exceed 0.32 pounds of volatile organic compounds per pound of coating solids, as mixed for application. The Department shall be notified for use of any alternate coating material having equal or lower VOC content in Source ID P114 other than previously approved by the Department.

(3) The volatile organic compound content of the topcoats used in the spray booth of Source ID P114 shall not exceed 0.32 pounds of volatile organic compounds per pound of coating solids, as mixed for application. The Department shall be notified for use of any alternate coating material having equal or lower VOC content in Source ID P114 other than previously approved by the Department.

**SECTION D. Source Level Requirements****II. TESTING REQUIREMENTS.**

No additional testing requirements exist except as provided in other sections of this permit including Section B (State Only General Requirements).

III. MONITORING REQUIREMENTS.

004 [25 Pa. Code §127.441]

Operating permit terms and conditions.

[Additional authority for this permit condition is derived from 25 Pa. Code Sections 127.1 and 127.12]

The spray booth of Source ID P114 shall be equipped with instrumentation to continuously monitor the differential pressure across the booth filters (ID C114).

IV. RECORDKEEPING REQUIREMENTS.

005 [25 Pa. Code §127.441]

Operating permit terms and conditions.

(a) The permittee shall keep records of the differential pressure across the booth filters (ID C114) of the spray booth of Source ID P114 on a weekly basis.

(b) These records shall be retained for a minimum of five (5) years and shall be made available to the Department upon request.

006 [25 Pa. Code §127.441]

Operating permit terms and conditions.

(a) The permittee shall keep records of the supporting calculations for VOC emissions on a monthly basis and shall verify compliance with the VOC emission limitation for the spray booth of Source ID P114 in any 12 consecutive month period.

(b) The permittee shall keep records of the supporting calculations for 'combined HAPs' emissions on a monthly basis and shall verify compliance with the 'combined HAPs' emission limitation for the spray booth of Source ID P114 in any 12 consecutive month period.

(c) These records shall be retained for a minimum of five (5) years and shall be made available to the Department upon request.

007 [25 Pa. Code §127.441]

Operating permit terms and conditions.

(a) The permittee shall maintain accurate and comprehensive records of the following:

1. The identity and amount of each individual coating/finishing material used each month in the spray booth of Source ID P114.
2. The identity and amount of each cleanup solvent used each month in cleanup activities associated with Source ID P114.

(b) The permittee shall maintain product composition sheets for all coating/finishing materials used in the spray booth of Source ID P114. At a minimum, the sheets shall identify the amount of volatile organic compounds, the amount of hazardous air pollutants and the amount of solids contained in each of the respective materials.

(c) These records shall be retained for a minimum of five (5) years and shall be made available to the Department upon request.

**SECTION D. Source Level Requirements****# 008 [25 Pa. Code §127.441]****Operating permit terms and conditions.**

Pursuant to 25 Pa. Code Section 127.12b, the permittee shall maintain daily records of the following:

(1) The following parameters for each coating, thinner, and other component as supplied for use in Source ID P114:

- (i) The coating, thinner, or component name and identification number.
- (ii) The volume used.
- (iii) The mix ratio.
- (iv) The density or specific gravity.
- (v) The weight percent of total volatiles, water, solids, and exempt solvents.

(2) The VOC content (lbs VOC/lb solids) of each coating, thinner, and other component as supplied.

(3) The VOC content (lbs VOC/lb solids) of each as applied coating.

(b) These records shall be retained for a minimum of five (5) years and shall be made available to the Department upon request.

V. REPORTING REQUIREMENTS.**# 009 [25 Pa. Code §127.441]****Operating permit terms and conditions.**

(a) The permittee shall submit reports to the Department on a semiannual basis that include the supporting calculations used to verify compliance with the VOC emission limitation for the spray booth of Source ID P114 in any 12 consecutive month period.

(b) The permittee shall submit reports to the Department on a semiannual basis that include the supporting calculations used to verify compliance with the 'combined HAPs' emission limitation for the spray booth of Source ID P114 in any 12 consecutive month period.

(c) The semi-annual reports shall be submitted by no later than September 1 (for the immediately-preceding July 1 through June 30 twelve consecutive month period) and March 1 (for the immediately-preceding January 1 through December 31 (twelve consecutive month period)). Reports due by March 1 shall be submitted via the Department's electronic Air Emissions System (AES) reporting system through the online DEP GreenPort. Reports due by September 1 shall be submitted as a pdf file in a format acceptable to the Department through the DEP OnBase online document submittal system or by e-mail attachment to the Regional Air Program Manager.

VI. WORK PRACTICE REQUIREMENTS.**# 010 [25 Pa. Code §127.441]****Operating permit terms and conditions.**

[Additional authority for this permit condition is derived from 25 Pa. Code Sections 127.1 and 127.12]

All volatile organic compound-containing or volatile hazardous pollutant-containing materials (coating/finishing) shall be stored in closed containers when not in actual use; spray gun lines shall be cleaned by flushing solvent through the lines and into closed containers; all used cleaning rags shall be stored in closed containers and shall never be "treated" so as to unnecessarily promote the evaporative loss of solvents to the atmosphere.

VII. ADDITIONAL REQUIREMENTS.**# 011 [25 Pa. Code §127.441]****Operating permit terms and conditions.**

[Additional authority for this permit condition is also derived from 25 Pa. Code Sections 127.1 and 127.12]

**SECTION D. Source Level Requirements**

Water or non-VOCs/non-HAPs material shall only be used for cleanup purposes or activities associated with Source ID P114.

012 [25 Pa. Code §127.441]**Operating permit terms and conditions.**

[Additional authority for this permit condition is derived from 25 Pa. Code Sections 127.1 and 127.12]

All coating/finishing materials used in the spray booth of Source ID P114 shall be applied using high volume low pressure (HVLP) or air-assisted airless spray technology.

013 [25 Pa. Code §127.441]**Operating permit terms and conditions.**

[Additional authority for this permit condition is derived from 25 Pa. Code Sections 127.1 and 127.12]

The particulate matter emissions from Source ID P114 shall be controlled by paint arrestor/filters (with a minimum control efficiency of 99%) (ID C114) at anytime the Source ID P114 is in operation.

014 [25 Pa. Code §127.441]**Operating permit terms and conditions.**

(a) Source ID P114 consists of a Col-Met, Inc. manufactured model B/F-12x12x7.5-FLO open face cross-draft dry filter spray booth (Spray booth #6) and associated Production Systems, Inc. manufactured model LTDFPO-D15-1673-300 0.8 MMBtu per hour natural gas fired drying/curing oven.

(b) ID C114 is Research Products Corporation manufactured arrestor filters (RP® Paint Arrestors) or other particulate matter filters with minimum control efficiency of no less than 99%.

**SECTION D. Source Level Requirements**

Source ID: P115

Source Name: AIR MAKE UP UNIT

Source Capacity/Throughput:

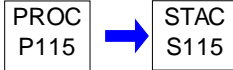
**I. RESTRICTIONS.****Emission Restriction(s).**

001 [25 Pa. Code §123.11]

Combustion units

No person may permit the emission of particulate matter from exhaust of Source ID P115 into the outdoor atmosphere in excess of 0.40 pound per million Btu of heat input.

002 [25 Pa. Code §123.22]

Combustion units

[Compliance with the requirement specified in this streamlined permit condition assures compliance with the requirements of 40 CFR 52.2020(c)]

No person may permit the emission into the outdoor atmosphere of sulfur oxides, expressed as SO₂, from exhaust of Source ID P115 in excess of the rate of 4 pounds per million Btu of heat input over any 1-hour period.

II. TESTING REQUIREMENTS.

No additional testing requirements exist except as provided in other sections of this permit including Section B (State Only General Requirements).

III. MONITORING REQUIREMENTS.

No additional monitoring requirements exist except as provided in other sections of this permit including Section B (State Only General Requirements).

IV. RECORDKEEPING REQUIREMENTS.

No additional record keeping requirements exist except as provided in other sections of this permit including Section B (State Only General Requirements).

V. REPORTING REQUIREMENTS.

No additional reporting requirements exist except as provided in other sections of this permit including Section B (State Only General Requirements).

VI. WORK PRACTICE REQUIREMENTS.

No additional work practice requirements exist except as provided in other sections of this permit including Section B (State Only General Requirements).

**SECTION D. Source Level Requirements****VII. ADDITIONAL REQUIREMENTS.****# 003 [25 Pa. Code §127.441]****Operating permit terms and conditions.**

Source ID P115 is a Rupp manufactured model CFA-36, 2.64 MMBtu per hour natural gas fired air make-up unit.

**SECTION D. Source Level Requirements**

Source ID: P117

Source Name: AUTO PAINT LINE

Source Capacity/Throughput:

**I. RESTRICTIONS.****Emission Restriction(s).****# 001 [25 Pa. Code §127.441]****Operating permit terms and conditions.**

[Additional authority for this permit condition is derived from 25 Pa. Code Sections 127.1 and 127.12]

(a) The volatile organic compound content of the coating(s) used in the auto spray machine of Source ID P117 shall not exceed 0.32 pounds of volatile organic compounds per pound of coating solids, as mixed for application. The Department shall be notified for use of any alternate coating material having equal or lower VOC content in Source ID P117 other than previously approved by the Department.

(b) The volatile organic compound content of the coating(s) used in the roll coater of Source ID P117 shall not exceed 0.01 pounds of volatile organic compounds per pound of coating solids, as mixed for application. The Department shall be notified for use of any alternate coating material having equal or lower VOC content in Source ID P117 other than previously approved by the Department.

002 [25 Pa. Code §127.441]**Operating permit terms and conditions.**

[Additional authority for this permit condition is derived from 25 Pa. Code Sections 127.1 and 127.12]

{Compliance with this permit condition assures compliance with the particulate matter emissions limitation of 25 Pa. Code Section 123.13}

The concentration of particulate matter emissions from the exhaust associated with the auto paint line of Source ID P117 shall not exceed 0.01 grains per dry standard cubic feet at any time.

003 [25 Pa. Code §127.441]**Operating permit terms and conditions.**

[Additional authority for this permit condition is derived from 25 Pa. Code Sections 127.1 and 127.12]

(a) The total volatile organic compounds emissions from the auto paint line of Source ID P117 shall not exceed 25.23 tons in any 12 consecutive month period.

(b) The total combined hazardous air pollutants emissions from the auto paint line of Source ID P117 shall not exceed 0.69 tons in any 12 consecutive month period.

II. TESTING REQUIREMENTS.

No additional testing requirements exist except as provided in other sections of this permit including Section B (State Only General Requirements).

**SECTION D. Source Level Requirements****III. MONITORING REQUIREMENTS.****# 004 [25 Pa. Code §127.441]****Operating permit terms and conditions.**

[Additional authority for this permit condition is derived from 25 Pa. Code Sections 127.1 and 127.12]

The auto paint line of Source ID P117 shall be equipped with instrumentation to continuously monitor the differential pressure across the booth filters (ID C117).

IV. RECORDKEEPING REQUIREMENTS.**# 005 [25 Pa. Code §127.441]****Operating permit terms and conditions.**

(a) The permittee shall keep records of the differential pressure across the booth filters (ID C117) of the auto paint line of Source ID P117 on a weekly basis.

(b) These records shall be retained for a minimum of five (5) years and shall be made available to the Department upon request.

006 [25 Pa. Code §127.441]**Operating permit terms and conditions.**

(a) The permittee shall keep records of the supporting calculations for VOC emissions on a monthly basis and shall verify compliance with the VOC emission limitation for the auto paint line of Source ID P117 in any 12 consecutive month period.

(b) The permittee shall keep records of the supporting calculations for 'combined HAPs' emissions on a monthly basis and shall verify compliance with the 'combined HAPs' emission limitation for the auto paint line of Source ID P117 in any 12 consecutive month period.

(c) These records shall be retained for a minimum of five (5) years and shall be made available to the Department upon request.

007 [25 Pa. Code §127.441]**Operating permit terms and conditions.**

(a) The permittee shall maintain accurate and comprehensive records of the following:

1. The identity and amount of each individual coating/finishing material used each month in the auto paint line of Source ID P117.
2. The identity and amount of each cleanup solvent used each month in cleanup activities associated with Source ID P117.

(b) The permittee shall maintain product composition sheets for all coating/finishing materials used in the auto paint line of Source ID P117. At a minimum, the sheets shall identify the amount of volatile organic compounds, the amount of hazardous air pollutants and the amount of solids contained in each of the respective materials.

(c) These records shall be retained for a minimum of five (5) years and shall be made available to the Department upon request.

008 [25 Pa. Code §127.441]**Operating permit terms and conditions.**

(a) Pursuant to 25 Pa. Code Section 127.12b, the permittee shall maintain daily records of the following:

- (1) The following parameters for each coating, thinner, and other component as supplied for use in Source ID P117:
 - (i) The coating, thinner, or component name and identification number.

**SECTION D. Source Level Requirements**

- (ii) The volume used.
 - (iii) The mix ratio.
 - (iv) The density or specific gravity.
 - (v) The weight percent of total volatiles, water, solids, and exempt solvents.
- (2) The VOC content (lbs VOC/lb solids) of each coating, thinner, and other component as supplied.
- (3) The VOC content (lbs VOC/lb solids) of each as applied coating.
- (b) These records shall be retained for a minimum of five (5) years and shall be made available to the Department upon request.

V. REPORTING REQUIREMENTS.**# 009 [25 Pa. Code §127.441]****Operating permit terms and conditions.**

- (a) The permittee shall submit reports to the Department on a semiannual basis that include the supporting calculations used to verify compliance with the VOC emission limitation for the auto paint line of Source ID P117 in any 12 consecutive month period.
- (b) The permittee shall submit reports to the Department on a semiannual basis that include the supporting calculations used to verify compliance with the 'combined HAPs' emission limitation for the auto paint line of Source ID P117 in any 12 consecutive month period.
- (c) The semi-annual reports shall be submitted by no later than September 1 (for the immediately-preceding July 1 through June 30 twelve consecutive month period) and March 1 (for the immediately-preceding January 1 through December 31 twelve consecutive month period). Reports due by March 1 shall be submitted via the Department's electronic Air Emissions System (AES) reporting system through the online DEP GreenPort. Reports due by September 1 shall be submitted as a pdf file in a format acceptable to the Department through the DEP OnBase online document submittal system or by e-mail attachment to the Regional Air Program Manager.

VI. WORK PRACTICE REQUIREMENTS.**# 010 [25 Pa. Code §127.441]****Operating permit terms and conditions.**

[Additional authority for this permit condition is derived from 25 Pa. Code Sections 127.1 and 127.12]

All volatile organic compound-containing or volatile hazardous pollutant-containing materials (coating/finishing) shall be stored in closed containers when not in actual use; spray gun lines shall be cleaned by flushing solvent through the lines and into closed containers; all used cleaning rags shall be stored in closed containers and shall never be "treated" so as to unnecessarily promote the evaporative loss of solvents to the atmosphere.

VII. ADDITIONAL REQUIREMENTS.**# 011 [25 Pa. Code §127.441]****Operating permit terms and conditions.**

[Additional authority for this permit condition is also derived from 25 Pa. Code Sections 127.1 and 127.12]

Only Water or non-VOCs/non-HAPs material shall be used for cleanup purposes or activities associated with Source ID P117.

**SECTION D. Source Level Requirements****# 012 [25 Pa. Code §127.441]****Operating permit terms and conditions.**

[Additional authority for this permit condition is derived from 25 Pa. Code Sections 127.1 and 127.12]

All spray-applied coating/finishing materials used in the auto paint line of Source ID P117 shall be applied using high volume low pressure (HVLV) or air-assisted airless spray technology.

013 [25 Pa. Code §127.441]**Operating permit terms and conditions.**

(a) Source ID P117 is an auto paint line which consists of the following equipment:

(1) One Superfici America manufactured model Automatic Spraying Machine Magnum 3.2.2 049001 spray machine.

(2) One Superfici America manufactured model "Valtorta F1" roll coater.

(3) and several electrically powered, non-emitting ancillary equipment like belt conveyors, four axis mechanical Robot unit, roller conveyor, panel turning unit, UV lamp dryers, IR-Preheater, brush roller etc.

(b) ID C117 is Superfici America manufactured three stage particulate matter filters with a combined dry control efficiency of 99.99%.

014 [25 Pa. Code §127.441]**Operating permit terms and conditions.**

[Additional authority for this permit condition is derived from 25 Pa. Code Sections 127.1 and 127.12]

The particulate matter emissions from Source ID P117 shall be controlled by paint arrestor/filters (with a minimum control efficiency of 99.99%) (ID C117) at any time the Source ID P117 is in operation.

**SECTION D. Source Level Requirements**

Source ID: P118

Source Name: MINI SPRAY BOOTH

Source Capacity/Throughput:

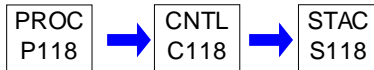
**I. RESTRICTIONS.****Emission Restriction(s).****# 001 [25 Pa. Code §127.441]****Operating permit terms and conditions.**

[Additional authority for this permit condition is derived from 25 Pa. Code Sections 127.1 and 127.12]

{Compliance with this permit condition assures compliance with the particulate matter emissions limitation of 25 Pa. Code Section 123.13}

The concentration of particulate matter emissions from the exhaust associated with the spray booth of Source ID P118 shall not exceed 0.01 grains per dry standard cubic feet at any time.

002 [25 Pa. Code §127.441]**Operating permit terms and conditions.**

[Additional authority for this permit condition is derived from 25 Pa. Code Sections 127.1 and 127.12]

(a) The total volatile organic compounds emissions from the spray booth of Source ID P118 shall not exceed 4.11 tons in any 12 consecutive month period.

(b) The total combined HAPs emissions from the spray booth of Source ID P118 shall not exceed 0.104 tons in any 12 consecutive month period.

003 [25 Pa. Code §127.441]**Operating permit terms and conditions.**

[Additional authority for this permit condition is derived from 25 Pa. Code Sections 127.1 and 127.12]

The volatile organic compound content of the coating used in the spray booth of Source ID P118 shall not exceed 0.32 pounds of volatile organic compounds per pound of coating solids, as mixed for application. The Department shall be notified for use of any alternate coating material having equal or lower VOC content in Source ID P118 other than previously approved by the Department.

II. TESTING REQUIREMENTS.

No additional testing requirements exist except as provided in other sections of this permit including Section B (State Only General Requirements).

III. MONITORING REQUIREMENTS.**# 004 [25 Pa. Code §127.441]****Operating permit terms and conditions.**

[Additional authority for this permit condition is derived from 25 Pa. Code Sections 127.1 and 127.12]

The spray booth of Source ID P118 shall be equipped with instrumentation to continuously monitor the differential pressure across the booth filters (ID C118).

**SECTION D. Source Level Requirements****IV. RECORDKEEPING REQUIREMENTS.****# 005 [25 Pa. Code §127.441]****Operating permit terms and conditions.**

(a) The permittee shall keep records of the differential pressure across the booth filters (ID C118) of the spray booth of Source ID P118 on a weekly basis.

(b) These records shall be retained for a minimum of five (5) years and shall be made available to the Department upon request.

006 [25 Pa. Code §127.441]**Operating permit terms and conditions.**

(a) The permittee shall keep records of the supporting calculations for VOC emissions on a monthly basis and shall verify compliance with the VOC emission limitation for the spray booth of Source ID P118 in any 12 consecutive month period.

(b) The permittee shall keep records of the supporting calculations for 'combined HAPs' emissions on a monthly basis and shall verify compliance with the 'combined HAPs' emission limitation for the spray booth of Source ID P118 in any 12 consecutive month period.

(c) These records shall be retained for a minimum of five (5) years and shall be made available to the Department upon request.

007 [25 Pa. Code §127.441]**Operating permit terms and conditions.**

(a) The permittee shall maintain accurate and comprehensive records of the following:

1. The identity and amount of each individual coating/finishing material used each month in the spray booth of Source ID P118.

2. The identity and amount of each cleanup solvent used each month in cleanup activities associated with Source ID P118.

(b) The permittee shall maintain product composition sheets for all coating/finishing materials used in the spray booth of Source ID P118. At a minimum, the sheets shall identify the amount of volatile organic compounds, the amount of hazardous air pollutants and the amount of solids contained in each of the respective materials.

(c) These records shall be retained for a minimum of five (5) years and shall be made available to the Department upon request.

008 [25 Pa. Code §127.441]**Operating permit terms and conditions.**

Pursuant to 25 Pa. Code Section 127.12b, the permittee shall maintain daily records of the following:

(1) The following parameters for each coating, thinner, and other component as supplied for use in Source ID P118:

(i) The coating, thinner, or component name and identification number.

(ii) The volume used.

(iii) The mix ratio.

(iv) The density or specific gravity.

(v) The weight percent of total volatiles, water, solids, and exempt solvents.

(2) The VOC content (lbs VOC/lb solids) of each coating, thinner, and other component as supplied.

(3) The VOC content (lbs VOC/lb solids) of each as applied coating.

(b) These records shall be retained for a minimum of five (5) years and shall be made available to the Department upon

**SECTION D. Source Level Requirements**

request.

V. REPORTING REQUIREMENTS.**# 009 [25 Pa. Code §127.441]****Operating permit terms and conditions.**

(a) The permittee shall submit reports to the Department on a semiannual basis that include the supporting calculations used to verify compliance with the VOC emission limitation for the spray booth of Source ID P118 in any 12 consecutive month period.

(b) The permittee shall submit reports to the Department on a semiannual basis that include the supporting calculations used to verify compliance with the 'combined HAPs' emission limitation for the spray booth of Source ID P118 in any 12 consecutive month period.

(c) The semi-annual reports shall be submitted by no later than September 1 (for the immediately-preceding July 1 through June 30 twelve consecutive month period) and March 1 (for the immediately-preceding January 1 through December 31 (twelve consecutive month period). Reports due by March 1 shall be submitted via the Department's electronic Air Emissions System (AES) reporting system through the online DEP GreenPort. Reports due by September 1 shall be submitted as a pdf file in a format acceptable to the Department through the DEP OnBase online document submittal system or by e-mail attachment to the Regional Air Program Manager.

VI. WORK PRACTICE REQUIREMENTS.**# 010 [25 Pa. Code §127.441]****Operating permit terms and conditions.**

[Additional authority for this permit condition is derived from 25 Pa. Code Sections 127.1 and 127.12]

All volatile organic compound-containing or volatile hazardous pollutant-containing materials (coating/finishing) shall be stored in closed containers when not in actual use; spray gun lines shall be cleaned by flushing solvent through the lines and into closed containers; all used cleaning rags shall be stored in closed containers and shall never be "treated" so as to unnecessarily promote the evaporative loss of solvents to the atmosphere.

VII. ADDITIONAL REQUIREMENTS.**# 011 [25 Pa. Code §127.441]****Operating permit terms and conditions.**

[Additional authority for this permit condition is also derived from 25 Pa. Code Sections 127.1 and 127.12]

Only water or non-VOCs/non-HAPs material shall be used for cleanup purposes or activities associated with Source ID P118.

012 [25 Pa. Code §127.441]**Operating permit terms and conditions.**

[Additional authority for this permit condition is derived from 25 Pa. Code Sections 127.1 and 127.12]

All coating/finishing materials used in the spray booth of Source ID P118 shall be applied using high volume low pressure (HVLP) or air-assisted airless spray technology.

013 [25 Pa. Code §127.441]**Operating permit terms and conditions.**

(a) Source ID P118 is a Global Finishing Solutions manufactured model IFPX-4 spray booth.

**SECTION D. Source Level Requirements**

(b) ID C118 is Chemco Mfg. Co. manufactured arrestor filters or other particulate matter filters with minimum control efficiency of no less than 98.66%.

014 [25 Pa. Code §127.441]

Operating permit terms and conditions.

[Additional authority for this permit condition is derived from 25 Pa. Code Sections 127.1 and 127.12]

The particulate matter emissions from Source ID P118 shall be controlled by paint arrestor/filters (with a minimum control efficiency of 98.66%) (ID C118) at anytime the Source ID P118 is in operation.

**SECTION E. Source Group Restrictions.**

Group Name: P101, P102 AND P103

Group Description: Joint conditions for all booths

Sources included in this group

ID	Name
P101	SPRAY BOOTH 1
P102	SPRAY BOOTH 2
P103	SPRAY BOOTH 3

I. RESTRICTIONS.**Throughput Restriction(s).****# 001 [25 Pa. Code §127.441]****Operating permit terms and conditions.**

[Additional authority for this permit condition is derived from 25 Pa. Code Sections 129.91 through 129.95]

No more than 100 gallons of strippable booth coating shall be used in Sources P101, P102 and P103 combined in any 12 consecutive month period.

II. TESTING REQUIREMENTS.

No additional testing requirements exist except as provided in other sections of this permit including Section B (State Only General Requirements).

III. MONITORING REQUIREMENTS.

No additional monitoring requirements exist except as provided in other sections of this permit including Section B (State Only General Requirements).

IV. RECORDKEEPING REQUIREMENTS.**# 002 [25 Pa. Code §127.441]****Operating permit terms and conditions.**

[Additional authority for this permit condition is derived from 25 Pa. Code Section 129.95]

The permittee shall maintain the following records for the coatings (including strippable booth coatings) used in Sources P101, P102 and P103 combined:

- (1) The identity and amount of each individual coating, coating component and coating additive (other than water) used during each month.
- (2) If a coating applied in Sources P101, P102 or P103 is mixed onsite from multiple components or if a coating has an additive (other than water) mixed with it onsite, the identity of the coating components and/or additives and the mix ratio of these components and/or additives for each different batch of coating.
- (3) The density of each coating, coating component and coating additive (other than water) used.
- (4) The volatile organic compound content (percent, by weight) of each coating, coating component and coating additive (other than water) used.
- (5) The volatile hazardous air pollutant content (percent, by weight) of each coating, coating component and coating additive (other than water) used.
- (6) The solids content (percent, by volume) of each coating, coating component and coating additive (other than water) used.

All records generated pursuant to this condition shall be retained for at least five (5) years and shall be made available to the Department upon request.

V. REPORTING REQUIREMENTS.**# 003 [25 Pa. Code §127.441]****Operating permit terms and conditions.**

The permittee shall submit a report each year listing the following information for the coatings (including strippable booth

**SECTION E. Source Group Restrictions.**

coatings) used in Sources P101, P102 and P103 combined:

- (1) The identity and amount of each individual coating, coating component and coating additive (other than water) used during each month of the prior year.
- (2) If a coating applied in Sources P101, P102 or P103 is mixed onsite from multiple components or if a coating has an additive (other than water) mixed with it onsite, the identity of the coating components and/or additives and the mix ratio of these components and/or additives for each different batch of coating.
- (3) The density of each coating, coating component and coating additive (other than water) used.
- (4) The volatile organic compound content (percent, by weight) of each coating, coating component and coating additive (other than water) used.
- (5) The volatile hazardous air pollutant content (percent, by weight) of each coating, coating component and coating additive (other than water) used.
- (6) The solids content (percent, by volume) of each coating, coating component and coating additive (other than water) used.

Each annual report shall be submitted to the Department by no later than March 1 of each calendar year (for the immediately-preceding January 1 through December 31 twelve consecutive month period) via the Department's electronic Air Emissions System (AES) reporting system through the online DEP GreenPort.

VI. WORK PRACTICE REQUIREMENTS.

No additional work practice requirements exist except as provided in other sections of this permit including Section B (State Only General Requirements).

VII. ADDITIONAL REQUIREMENTS.

No additional requirements exist except as provided in other sections of this permit including Section B (State Only General Requirements).

**SECTION E. Source Group Restrictions.**

Group Name: P106A AND P112

Group Description: Cleanup Solvent Usage

Sources included in this group

ID	Name
P106A	PREFINISH LINE ADDITION #1
P112	SPRAY BOOTH 5

I. RESTRICTIONS.**Throughput Restriction(s).**

001 [25 Pa. Code §127.441]

Operating permit terms and conditions.

[Additional authority for this permit condition is derived from 25 Pa. Code Sections 127.1 and 127.12]

No more than a combined total of 75 gallons of volatile organic compound-containing material or volatile hazardous air pollutant-containing material shall be used in any 12 consecutive month period for cleanup activities associated with Sources P106A and P112. Additionally, the permittee may use acetone for cleanup activities associated with Sources P106A and P112.

II. TESTING REQUIREMENTS.

No additional testing requirements exist except as provided in other sections of this permit including Section B (State Only General Requirements).

III. MONITORING REQUIREMENTS.

No additional monitoring requirements exist except as provided in other sections of this permit including Section B (State Only General Requirements).

IV. RECORDKEEPING REQUIREMENTS.

No additional record keeping requirements exist except as provided in other sections of this permit including Section B (State Only General Requirements).

V. REPORTING REQUIREMENTS.

No additional reporting requirements exist except as provided in other sections of this permit including Section B (State Only General Requirements).

VI. WORK PRACTICE REQUIREMENTS.

No additional work practice requirements exist except as provided in other sections of this permit including Section B (State Only General Requirements).

VII. ADDITIONAL REQUIREMENTS.

No additional requirements exist except as provided in other sections of this permit including Section B (State Only General Requirements).

**SECTION F. Alternative Operation Requirements.**

No Alternative Operations exist for this State Only facility.



SECTION G. Emission Restriction Summary.

No emission restrictions listed in this section of the permit.



SECTION H. Miscellaneous.

The following air contaminant sources are considered to be insignificant in regards to air contaminant emissions and have been determined by the Department to be exempt from permitting requirements. However, this determination does not exempt the sources from compliance with all applicable State and Federal regulations and all applicable air quality regulations specified in 25 Pa. Code Chapters 121-143:

- (a) one (1) Fox Jet printer at the door trimming unit (estimated ink usage is 2 pints ink per year)
- (b) Ventilation system associated with electric forklift battery charging area (exempted from plan approval 11/3/98)
- (c) Two sanders associated with the auto paint line. The particulate matter emissions from the sanders associated with Source ID P117 shall be vented inside the building at the facility at all times.



***** End of Report *****
